

2020 - 2023

STUDIO20 | ARCHITECTS

CONTEMPORARY BESPOKE KITCHEN DESIGN

CONTENTS

Seamless	006
Fabia	014
Sirius	020
Neta	026
Flawless	030
Black Royal	036
Odin	038
Soho	044
Metallic	050
Karma	054
Classica	060
Shaker	066
Luna	074
Roseine	080
Nova	082
Sleek	088
Majestica	094
Royal	100
Sense	102
Oasis	108
Historia	114
Stream	120
Sky Soft	126
Siena	134
Linen	142
Youna	148
Utility & Pantry	154
Kitchen Storage and Organisation Solutions	160
Front Panels	184
Color & Texture Concepts	192
Handle Selections	206
Worktops	216

OUR STORY

Over the past 35 years, we have created stunning luxury spaces that make a real difference in how customers use their space. During our time so far, we have seen many changes in trends, lifestyles, needs, colours and technology for your kitchen. As a result, we have proudly developed our furniture and refined our processes to reflect the ever-changing world.

Our factory has an area of 3500 m², where it carries out its production and manufacturing activities, and our amazing team of creative and talented designers continuously challenges existing ideas to create new and stimulating designs for our clients.

Through growing, we have always stayed true to our design values, placing form and functionality at the forefront of each project.



Seamless

The stylish black handleless kitchen is a strong choice move that can transform the look d feel of your kitchen and dining experience.





Black kitchen cabinets make a bold statement and are particularly impressive when installed full length from floor to ceiling. We always advise combining softer, subtle tones to the space to counterbalance the deep rich lighting.



Additionally, a simple yet elegant lighting solution can bring a calming and atmospheric atmosphere to any room. Whether you choose under cabinet lighting or dimming devices, enhance your lighting for any occasion.

We pride ourselves on our attention to detail, from aesthetically pleasing to flawlessly functional; our tall units are designed with continuous fronts that are subtle and discreet but with ample storage solutions. The options for clever storage are endless, from bulky crates and cumbersome boxes to shelving and rail design features.



BESPOKE KITCHEN DESIGN

Our designs reflect our client's desires - no two designs are the same. We offer a tailored colour-matching service for clients who want to adhere to a colour scheme that runs through the house or in the kitchen. With over 100 colours to choose from, we can create a perfect finish that suits your tastes. Our talented team, from designers and project managers to our skilled craftsman and support staff, we love building stunning and practical solutions for your home. Your home is a reflection of you, so we make it our mission to create perfectly bespoke pieces, including storage spaces, utility rooms, kitchen counters and artisan furniture that guarantees professional service and exceptional craftsmanship that last a lifetime.

Our mission is to design spaces unique to you and your family. Every kitchen we design and install is tailored to your requirements and tastes. We love collaborating with our clients to achieve individuality, creativity and personalised solutions for your home.



Fabia



Create a confident and influential presence in your kitchen with a marble-style ceramic block design and wood accents. The dynamic yet comforting installation blends nature with contemporary style and creates a room with endless possibilities and tone. Wood has the wonderful benefit of adding value to any home and creating an attractive and warm feeling in any room.









By using a marble look quartz feature, your kitchen will radiate elegance and fineness. The quintessential marble swirls against the backdrop of the white and wooden cabinets sets a graceful movement to the whole design. At the same time, the complementary brass handles produce a mesmerising effect that lifts the entire space.





Part of the beauty and spectacle of having a bespoke kitchen designed just for you is that you can be as bold or discreet as you like. The remarkable hidden panelled storage doors offer clean lines and a subtle finish, while the clever mechanics allows the space behind to be used as an excellent storage source. To the unknowing observer, the wall looks like a continuous wall with no breaks, yet it is so much more to you.



Neta

Stylish and timeless glass cabinets add a contemporary glow to any kitchen architecture. Glass cabinets allow plans for the kitchen to be light, airy and open, which is great if you divide the space for a living or dining room. Tailoring your glass cabinets for size and frame materials gives you all the licence you need to have them built to your exact specifications.





HOW WE WORK

Sharing our client's vision is the most important stage of the process. It is the starting point upon which the rest of the design can be built. Your designer to collaborate, advise, guide and offer exquisite solutions for your kitchen renovation. From analysing the space and discussing your lifestyle and functional needs to understanding the space and getting the best from it, your designer is here to create a bespoke kitchen for your home.

Explore The Collections

We always encourage our clients to spend time looking at our work. Using our brochures, examples and showroom, you can properly understand our capabilities and gain inspiration for your own remodel.

Consultation

Contact us to arrange a time to come and have a full consultation with one of our trained and skilled kitchen designers. Within the session, we will discuss your dream kitchen, wish lists, dimensions, colour schemes, and mood boards to start shaping your ideal kitchen.

Visualising Your Space

After the initial consultation, we will visit your home to get a full picture of your layout, dimensions, window placements, natural lighting and environment to start building the next phase of the process.

The Devil Is In The Detail

As part of the complete design service we will present a 3D plan so you can get a proper sense of how your kitchen will look and feel. Through this stage, we will help you decide on appliances, colour schemes, flooring, tiles, lighting, and any other piece of the puzzle that needs to be considered.





With style and elegance, the thin worktop of Flawless emphasises the design's lightness and clean, exquisite lines. Its linear design language provides a clear image, especially without handles. The design allows freedom for personal interpretations, making the result appear utterly opulent, depending on your choice of materials and colour.

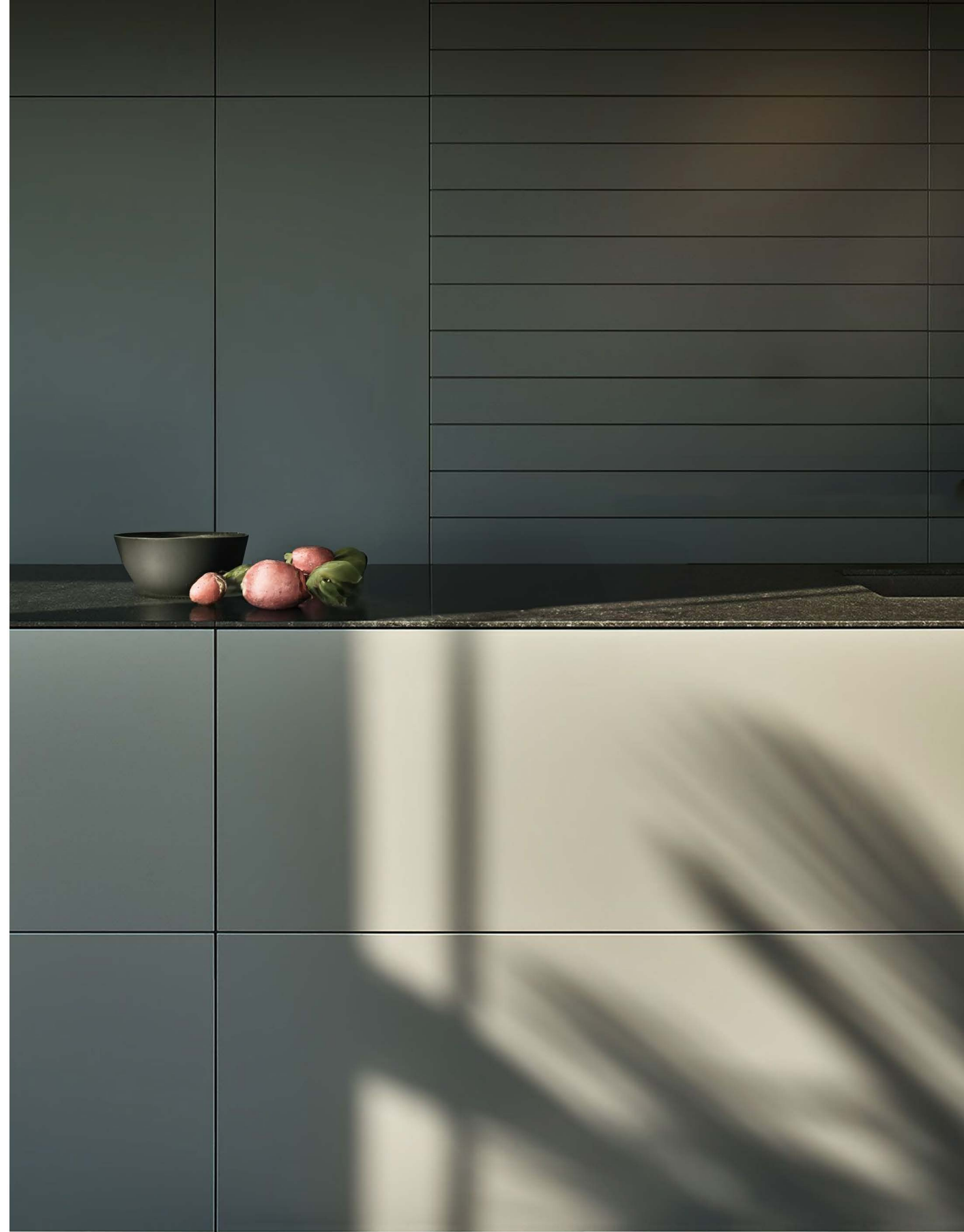

Black Royal

An exciting mix of wood and dark results in durable, traditional and contemporary kitchen architecture, also reflected in the precise spatial composition of tall units and wide islands.



Odin







When considering best practices in the kitchen, tall wooden cabinets complement the kitchen island and contemporary appliances with flair and elegance.



Natural and comforting, nothing exudes more warmth and charm than a wooden kitchen. The natural finish suits any home, whether modern or traditional. The intricate and visible grains ensure that every kitchen is different and unique. Rich and versatile, you can opt for contemporary or classic wood design finishes.

Soho



The modern joy of handle-free drawers combines the clean lines and smooth surfaces with classic, timeless style. With Push-pull handle-free, doors and drawers can be completely handle-free. Consider aged brass for your home; it remains firmly on trend in kitchen design and suits all tastes. The aged brass is practical, beautiful, and warm tones help create a stunning interior.



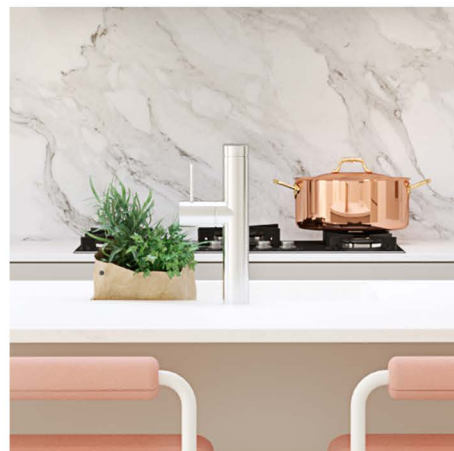
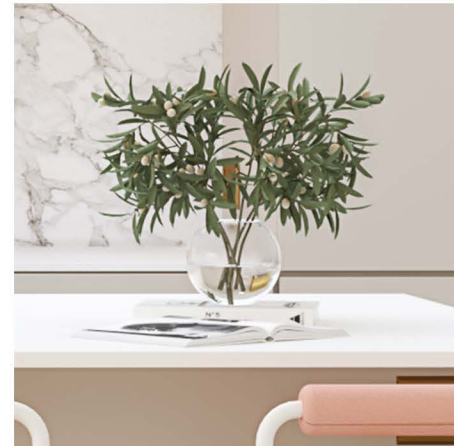

Metallic

Slick and stylish metallic accents in the kitchen are a trend that is here to stay. The black handle-less cabinets with gold colour metal inflexions lift and enunciate any space. The striking contrasts bring a beautiful balance between the design elements. The matte black, high-end kitchen cabinets make the marble look quartz backsplash sparkle. The spacious open-plan design enhances the room's flow and allows light to stream in more easily. In addition, floor-to-ceiling cabinets, the décor, and finishes, vertically elongate the space, making it feel even roomier and more playful as a result.



THE INDIVIDUAL KITCHEN

At Studio 20 Architects, we provide solutions to your design and renovation needs. Whether you have a small flat, a large apartment or a house, we want to build you your dream kitchen. From discreet storage solutions and state-of-the-art technology to warm accents, extra light, natural flow and a comforting atmosphere, our bespoke approach works to your tastes, dimensions and space.

We can provide complete solutions to fit your needs with various colour choices, classic finishes, and spatial attention. From wood and concrete to matt, high gloss, lamination and lacquer, whatever combinations of floors and surfaces you require, we can help.



Karma



Though traditionally considered an outdoor material, concrete is incredibly attractive in the home. Surrounded by softer materials and gentler tones, concrete can look homely and charming. The concrete acts as a subtle backdrop to allow the other features in your kitchen to take centre stage. White looks even brighter, while the wood can appear to have more character and the beige more intense and vibrant.



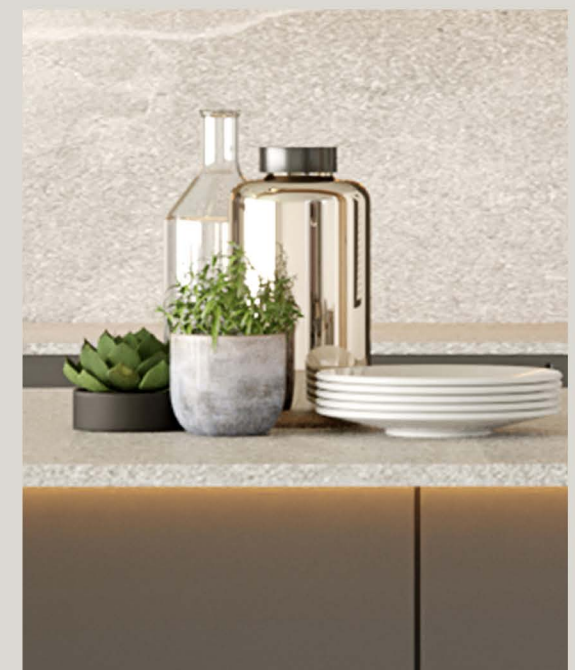

Classica

Panelling is a classic and innovative way of creating warmth and style while never dating. Give your kitchen a classic look that feels inviting with doors, drawer fronts, soft lines, and a stylish inset panel. We have various panel choices, so you can pick a style that works for you.









Shaker

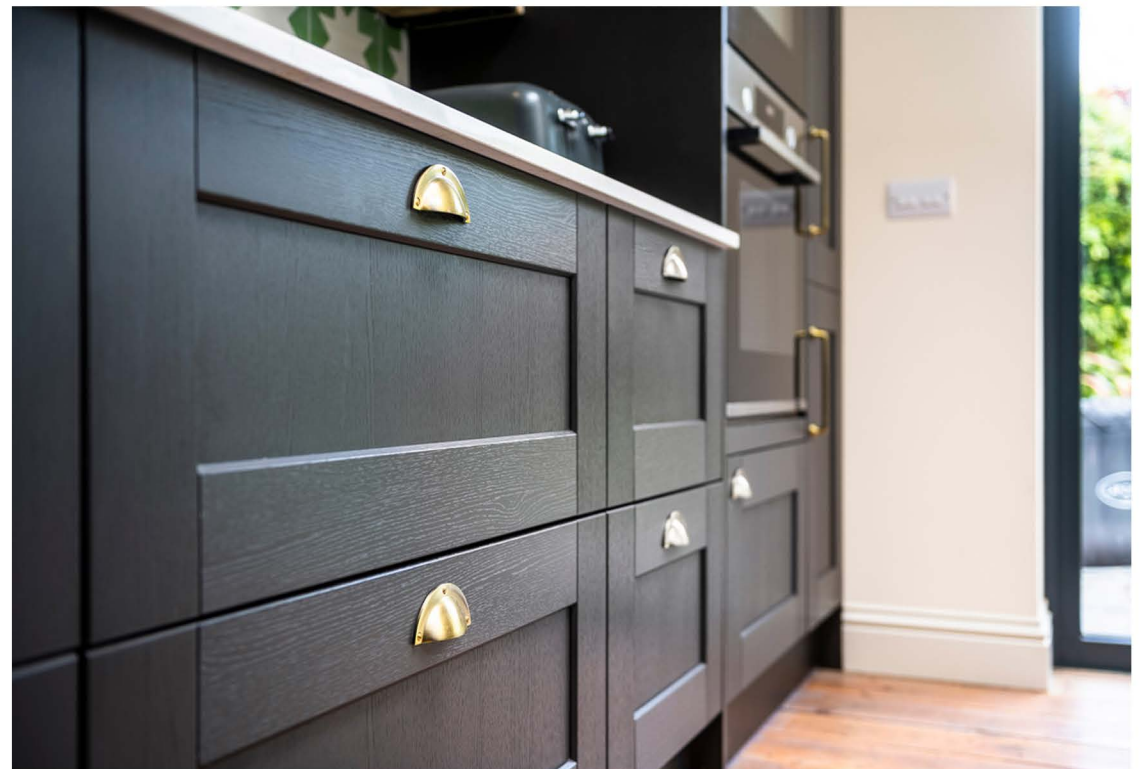



Express your personality and reflect your tastes with bold, contemporary and innovative design notes. By adding rich colours and textures to your kitchen design, you will be excited to show your kitchen off to family and friends every chance you get. We are delighted to collaborate with families on projects that elevate their current space and reflect their lifestyles. We have had the privilege of working collaboratively with families who want us to create a traditional, elegant space that would suit their large families and provide them with a dazzling area where they can entertain friends, enjoy family time, cook up a storm and truly relax.

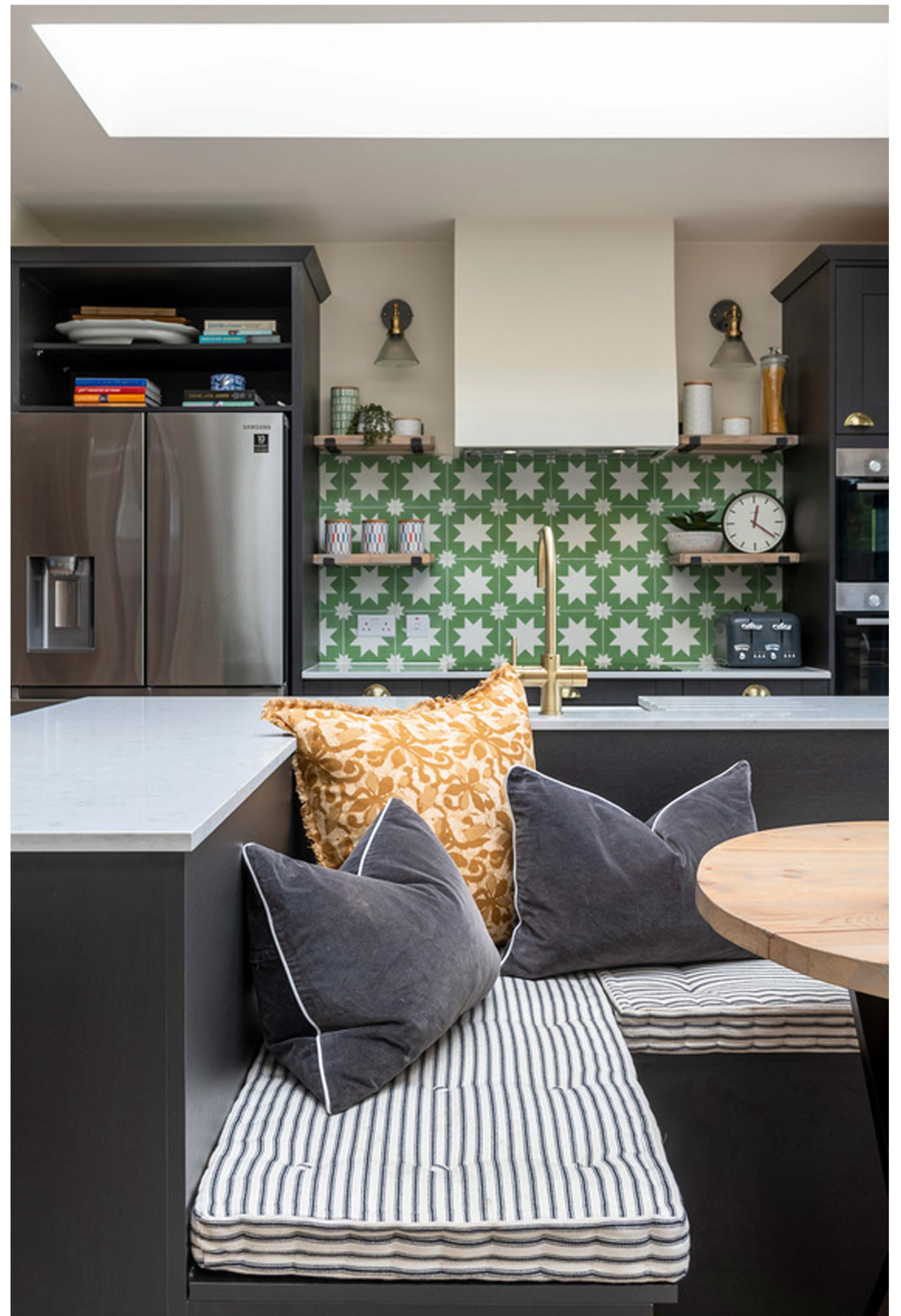

FUNCTIONALITY - QUALITY - ENJOYMENT

Functional Fun

Though the design is important, the kitchen is fundamentally a place of functionality. Whether you cook a lot, entertain frequently or have a busy household, the practicalities and flow of the kitchen are key to balance and an easier life.

High-Quality

Our kitchens are produced by experts in Turkey who have exceptional standards, are skilled craftsmen and have built an entire manufacturing process that ensures quality control, precision and attention to detail are at the height of their observations and mastery.

Lasting Joy

The combination of quality, resilience and practical solutions equate to utter balance and enjoyment. Your dream kitchen is just around the corner with our blend of creative designs, exquisite craftsmanship, flawless installations and exceptional outcomes.



Luna





For clean lines, modern style and multiple options, glass door fronts create a sleek and stylish cabinet to suit any home. The beauty of glass is its ability to complement other materials and styles easily. Whether your kitchen features wood, metal or stone, glass cabinets work beautifully within any design.



Roseine

The kitchen is the hub of your home and the comfort of your house. The metal textured Roseine combines a high degree of material aesthetics and linear design, expressing connoisseurship and reassuring elegance.



Nova





Are you looking to give your kitchen a classic, timeless look? Then the blue shaker-style kitchen with marble look quartz worktop and splashback is just what you need! This design combines modern aesthetics with traditional elements for an eye-catching result. The brass bar handles add a touch of elegance while the various panel choices allow for customization that will suit any style.

The blue shaker cabinets are perfect if you're going for a more subtle yet stylish aesthetic in your home. They come in several shades so there's sure to be one that fits your decor perfectly.

If you want something even more unique then consider opting for different panels on each cabinet door or drawer front - this can create interesting patterns which add character without compromising on functionality.

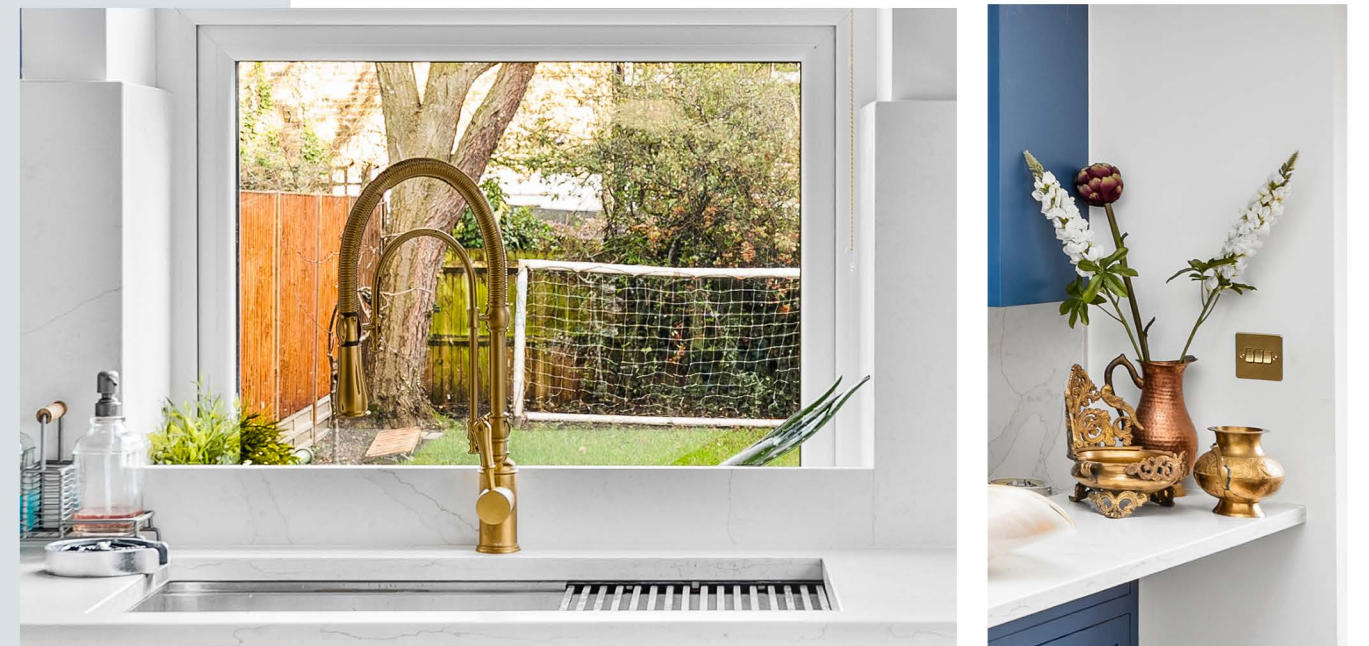



Sleek





The kitchen is the heart of the home; it is the space we cook for our family, dine with friends, entertain, relax and work; it is all things to the home. At Studio 20 Architects, we are your first choice for kitchen solutions. When creating style and features in the kitchen, monochromatic colour schemes of classic black and white are hard to beat. The timeless look adds a blend of old and new to create slick and stylish finishes.







Majestica

We are proud to call Majestica one of our most popular, timeless kitchen ranges. The versatile design is a symbol of quality and true craftsmanship, so whether you favour traditional over contemporary or the other way around, we can create smart solutions for your home with this exquisite range.







Royal

Sophisticated and minimal fashion, our Royal range evokes clean and aesthetically pleasing lines, a warm-yet-neutral colour palette, clever features, ergonomic practicality and a welcoming ambience.

Sense

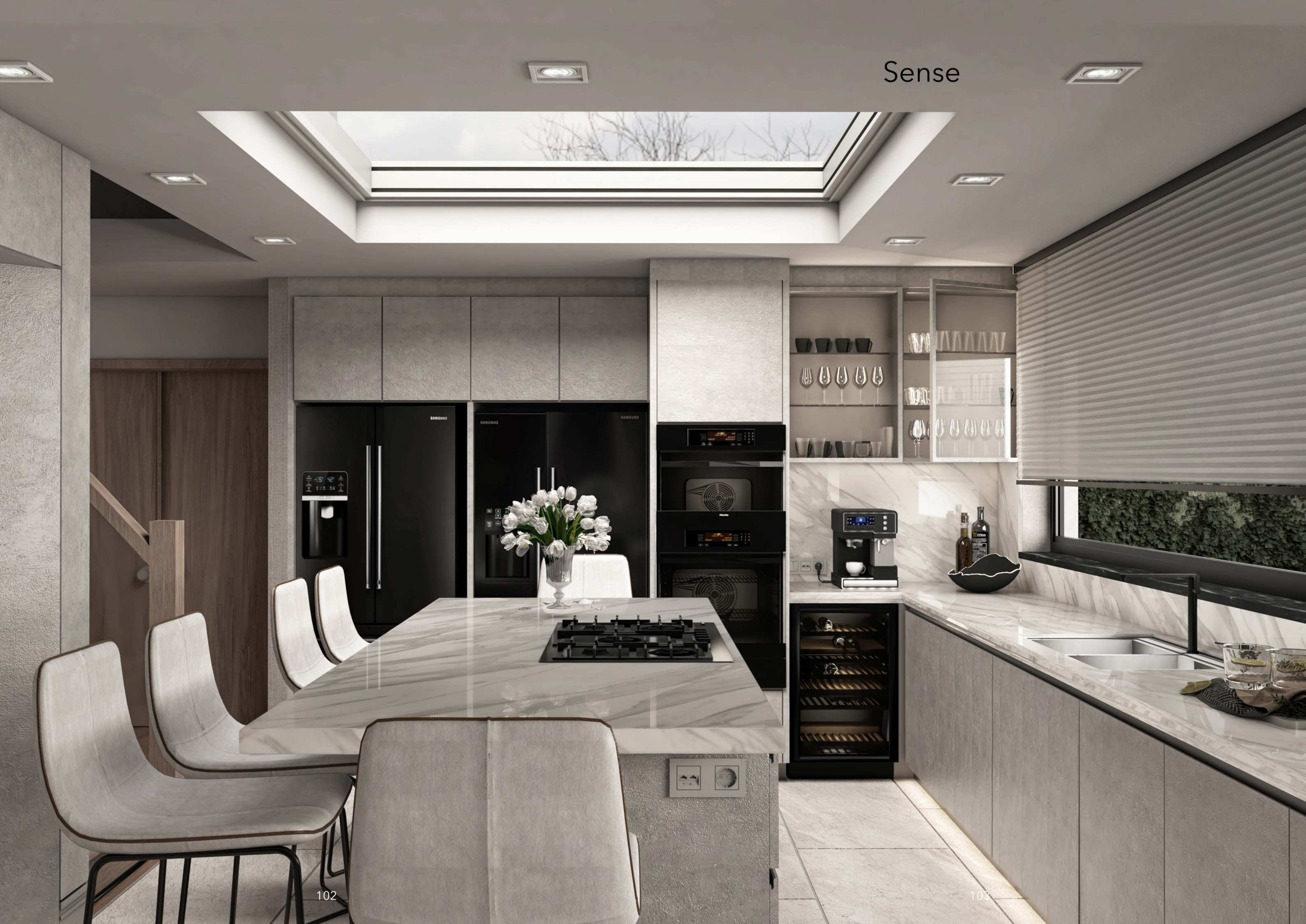





Concrete is the ideal choice for modern and durable architecture in the home. Aesthetically it looks classic and serves as the perfect backdrop for fittings and fixtures, and as a material for the kitchen, it offers character, durability and attractive finishes.



Calm, continuous and discreet best describe the beauty and pleasure of cabinets and open shelving that offer solutions for keeping surfaces clean and tidy with trays and dividers.



The oak surface is characterful and refined with warm earthy tones that beautifully offset the matt lacquer in the cool carbon grey. Whether you choose an oak surface, a carbon grey front, a combination of the two or one of the others in our wide range of colours and materials, you will be spoilt for choice.

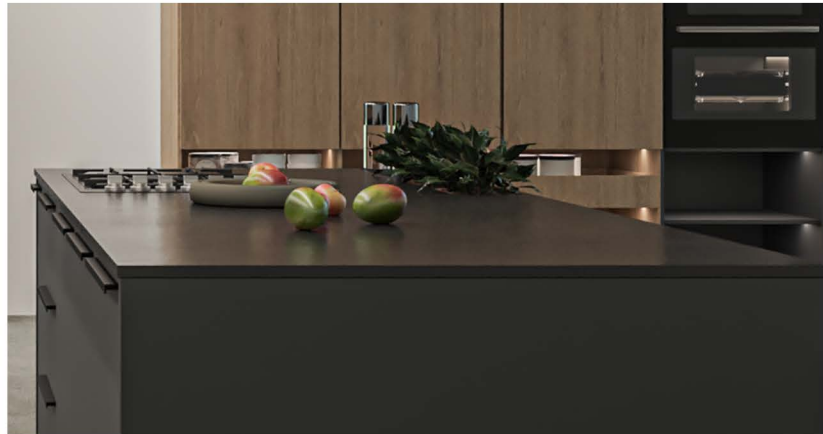

Historia







Stream





By extending just 3 meters to the tail end of the house, you could achieve an open plan kitchen, living and dining area, which offer a seamless connection to the garden.

This design is enhanced with a full glass bay window, an 8-meter long skylight and an L-shaped skylight at the open plan living, dining and kitchen area to maximise natural light flowing. In addition, the bi-folding door is a magnificent way to add character, charm and warmth to the space.







Sky Soft

Sky Soft designs combine the kitchen's functionality with the cosiness of the living area. The homely and comforting feel of this design brings open spaces from each area to blend charm, inclusivity and atmosphere with the practicality of the timeless white elegance of the kitchen to the warmth, delicate wooden edges and exceptional panelling of the living room area to create a feeling of flow when transitioning from one space to the other.



128



129





RESPONSIBILITY - ERGONOMY - DURABILITY

Climate Care

Building and creating a beautiful kitchen doesn't have to mean abandoning your environmental responsibilities. Our kitchens are all sustainably manufactured in Turkey; from the wood materials we source to the products we use, we proudly offer a carbon-neutral service to our clients.

Enormously Ergonomic

You must design your kitchen to meet your needs, not the other way around. From electrical outlet placements, lighting, worktops, heights, dimensions and widths to the overall flow of the kitchen space, we deliver all possibilities available to ensure your kitchen is working for you.

Deliberately Durable

Renovating a kitchen is expensive; it can be time-consuming and inconvenient for a time. So we design and build your kitchens to last! The longer you are satisfied with your kitchen, the better for the environment, which is why we always pick quality materials, the best suppliers, and manufacturing processes and provide specialist solutions to ensure longevity and aesthetic beauty.



Siena





WELCOME TO THE COMFORT ZONE

Inclusivity, creativity, sociability and connectivity, whether you own a lavish townhouse, a countryside cottage, a sizable apartment, a spacious loft conversion, or a city flat, open-plan is here to stay! When designing homes that flow freely with an open-plan structure, the focus is on blending functionality with sheer comfort. Whether you decide to coordinate surfaces and furniture or deliberately differentiate by adding tasteful contrasts to distinguish rooms, we see the merits of both. The focus in the living area is comfort, whereas the workplace requires orderliness and fewer distractions. The kitchen needs to have flow and functionality but also provide a calm ambience to reflect the living space; whatever you desire for your home we can offer sound advice and happy solutions.



Linen





Built-in, full-length kitchen cabinets are often used for integrated appliances providing an elegant, seamless and orderly solution for your kitchen. Likewise with The Open Shelf Base Cabinet. The cabinet offers aesthetic appeal and storage resolutions for your kitchen space. The eye-catching feature can display tableware, crockery, glasses, books, and bottles with timeless exquisitely. Our kitchens are built on beauty, practical design and bringing the essence of the home into one space. Our modern kitchens offer all the benefits necessary to create delicious meals or enjoy a relaxing breakfast on a lazy Sunday morning.









When it comes to modern kitchen design, there is something undeniably chic about a stone-textured matte black kitchen. This look has been gaining popularity in recent years as homeowners seek out sleek and sophisticated designs that make a statement. With its neutral color palette and timeless appeal, this style of kitchen can easily become the focal point of any home.



To achieve this look, start with floor-to-ceiling cabinets in an all-black finish for maximum impact. For added texture, opt for handleless cabinets with metal accents like brushed brass that will add visual interest without detracting from the overall aesthetic.





To complete the space consider adding marble-look quartz worktops which offer a luxurious feel while providing durability against everyday wear and tear - perfect for busy family homes!

UTILITY & LAUNDRY ROOMS

One of our most popular features is the utility room. Laundry items can be clunky, from washing machines and dryers to laundry baskets, cleaning products, ironing boards, drying rails and hampers; utility rooms free up your kitchen and give your house extra space. Regardless of the area, we will always find sound solutions to ensure your utility room has enough storage solutions for your requirements. For example, we often install tall cupboards higher up so the washing machine and dryer can be placed under them to avoid taking up extra floor space.

A utility room can be a handy place to store bulk items, long-life food, recycling bags and lesser-used kitchen appliances, making it easier to keep your kitchen organised. Though often the smallest room in the house, there are plenty of opportunities to make the most of the space and use the room to its full advantage.



UTILITY & LAUNDRY ROOMS

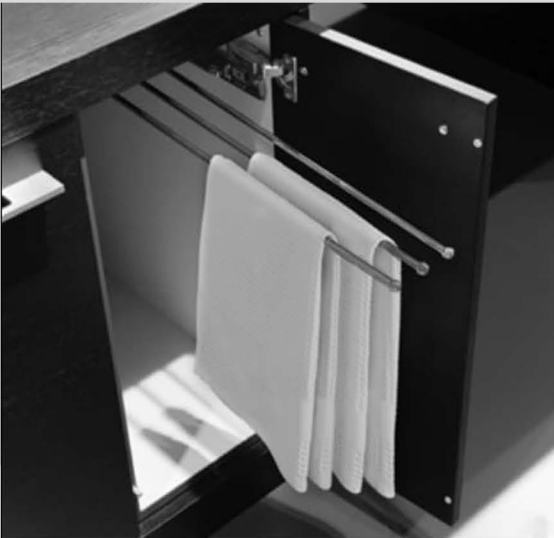

UTILITY & LAUNDRY ROOMS



Kitchen Storage & Organisation Solutions

Whether you are a keen chef or not, cooking in one of our kitchens is always a delight. The usage and flow of your kitchen space are at the forefront of our minds when designing the room. So, regardless of how much you love cooking, your kitchen will always be easy to use, free-flowing and developed to make cooking more accessible and entertaining more inviting.

Storage is the key to better maintenance, good organisation, effective use of the space and aesthetic appeal. Generous storage guarantees proper spatial awareness and a slicker design, whether your kitchen is large or small. We aim always to maximise the available space and layout to make room for better functionality and useability. Storage for kitchens is blocked out to keep essentials organised and lessen chaos, making tidying up swift and straightforward. Shelving and drawers are usually fitted discreetly behind cabinet doors for seamless style and easy, effortless reach to all your daily items, including utensils, pots and plates.



KITCHEN STORAGE

/ CORNER SOLUTIONS

Dead space in kitchens can be a huge problem when extra storage is required. Most kitchens contain hidden corner spaces which are difficult to reach; our corner storage units eliminate these blank spaces and make it easier to access the full cupboard. Our tailored solutions consistently use the space most practically.



KITCHEN STORAGE

WASTE BINS



Pull-out bins make a more ingenious space saver for your cupboards. These discreet and concealed pull-out bins come in multiple styles, shapes, sizes and colours to ensure your kitchen bin is hidden and you can easily prioritise your recycling.



KITCHEN STORAGE

/ PANTRY SOLUTIONS



A great place to store dry goods and other long-lasting grocery items, larder storage cupboards offer sturdy drawers and shelving to help keep life organised. Bespoke shapes and sizes mean you can tailor your storage to suit your space and not the other way around.

Available in different heights and widths to match any layout.

KITCHEN STORAGE

/ PANTRY SOLUTIONS



KITCHEN STORAGE

/ PANTRY SOLUTIONS



KITCHEN STORAGE

/ CABINET SOLUTIONS

Storage solutions for the kitchen are one of the most requested and necessary components when designing a kitchen space.

Using the latest technology for pull-out drawers and cupboards, our tailored storage solutions are made with quality materials, and state-of-the-art cushioned, quiet closing for the ultimate first-class results.



KITCHEN STORAGE

/ CABINET SOLUTIONS



KITCHEN STORAGE

/ DRAWER SOLUTIONS



Cutlery drawers can be chaotic; using a cutlery drawer insert will make finding everything you need quicker, safer and faster. Cutlery trays for drawers are designed to have a shallow depth for a comfortable fit and have built-in dividers to make organising cutlery effortless.

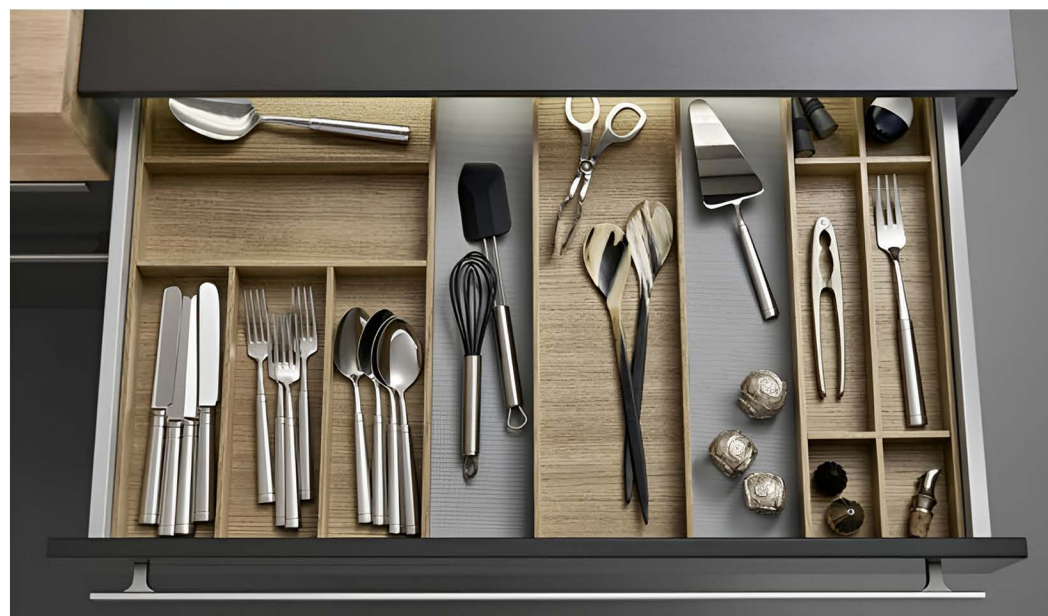

KITCHEN STORAGE

/ DRAWER SOLUTIONS

Modern design solutions for the kitchen have developed significantly over the years; storage solutions for the kitchen are one of the most requested and necessary components when designing a kitchen space. Using the latest technology for pull-out drawers and cupboards, our tailored storage solutions are made with quality materials, built-in dividers, and state-of-the-art cushioned, quiet closing for the ultimate first-class results.



KITCHEN STORAGE

/ DRAWER SOLUTIONS

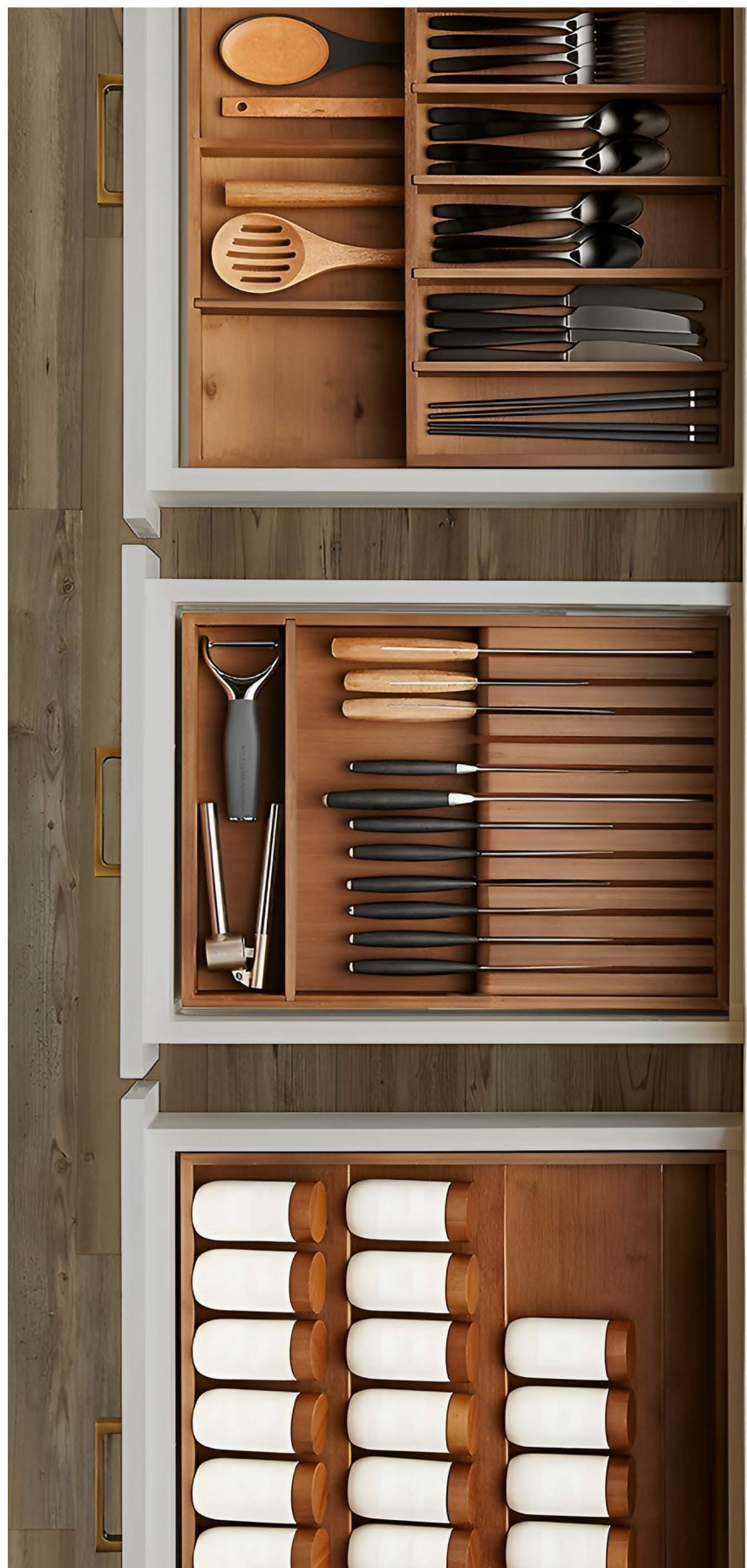
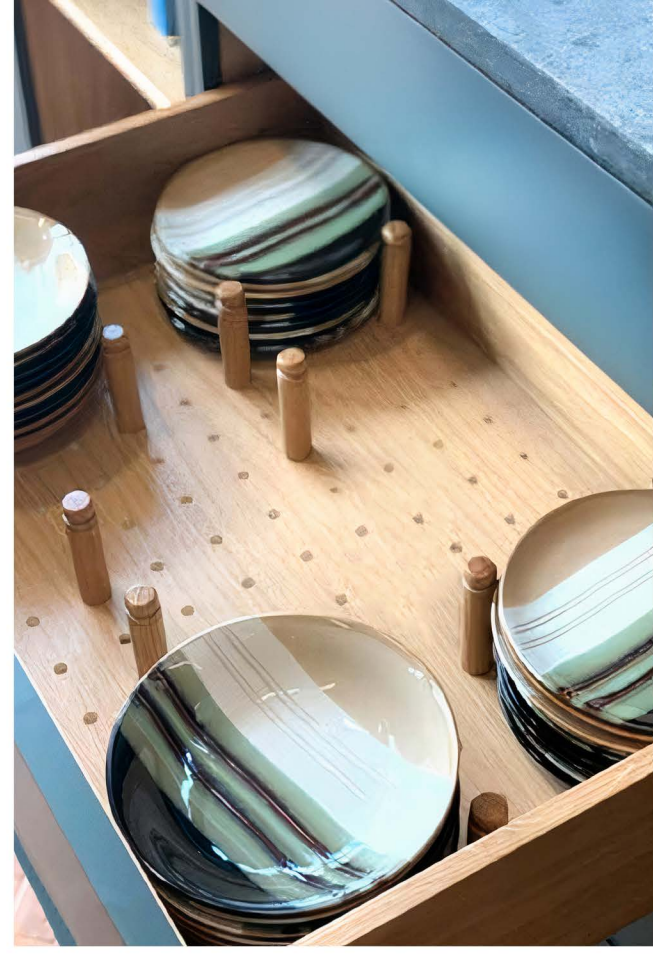

Aesthetically pleasing and highly functional, wall storage keeps necessities close at hand while cooking and is the easiest way to store and organise items without wasting valuable floor space.



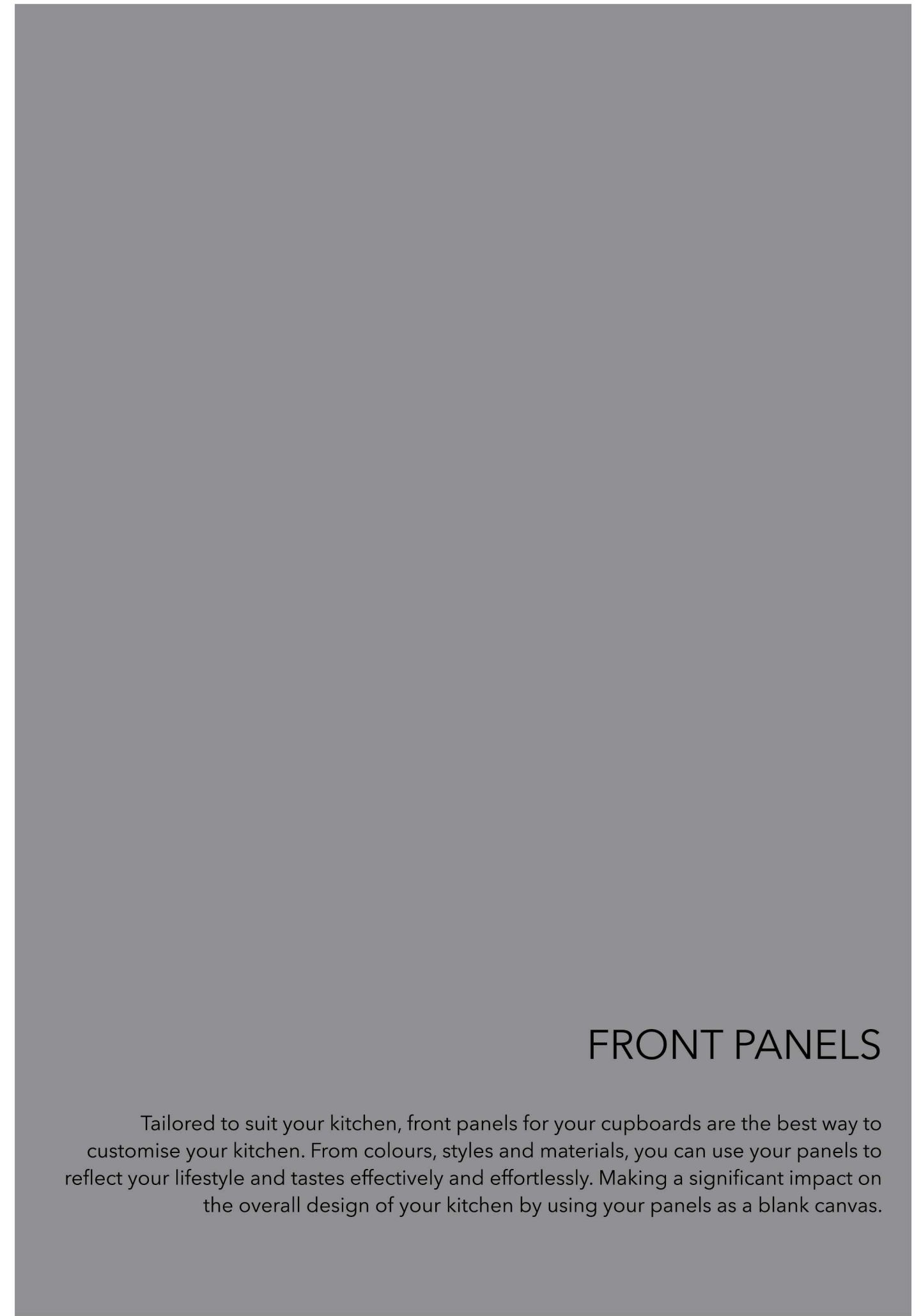

FRONT PANELS

Tailored to suit your kitchen, front panels for your cupboards are the best way to customise your kitchen. From colours, styles and materials, you can use your panels to reflect your lifestyle and tastes effectively and effortlessly. Making a significant impact on the overall design of your kitchen by using your panels as a blank canvas.

FRONT PANELS

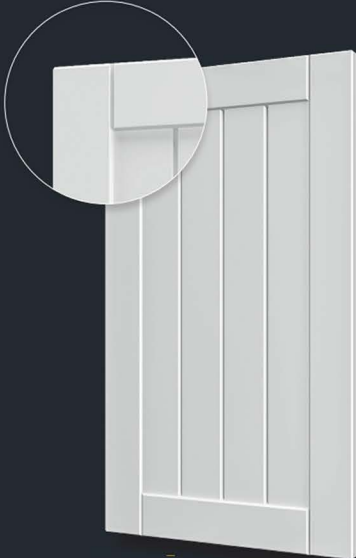

KAB-501



KAB-502

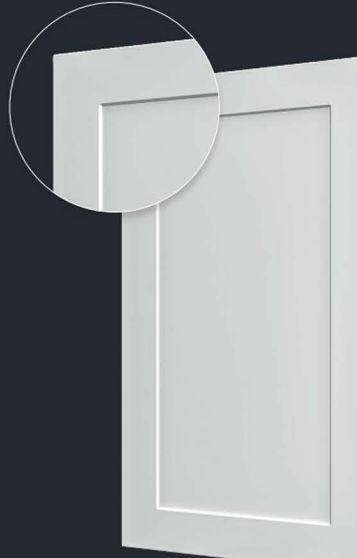

KAB-503



KAB-601

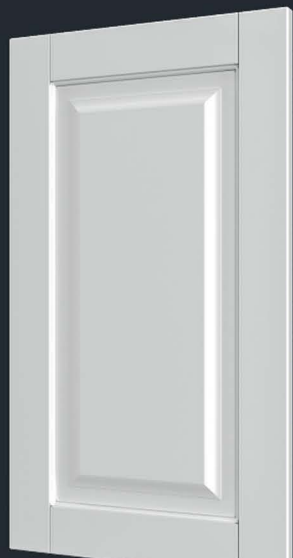

K-72



K-82

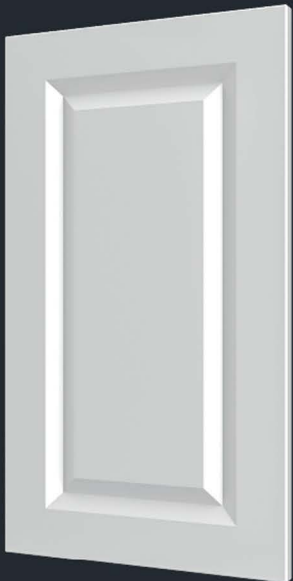

K-84

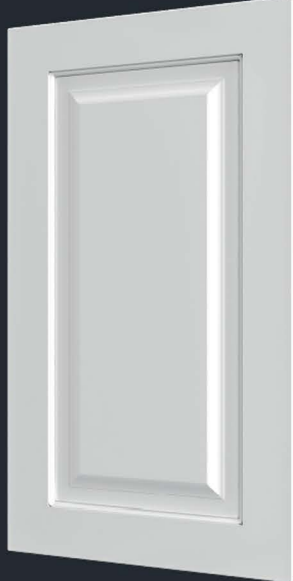

K-101



K-103



K-116



K-120

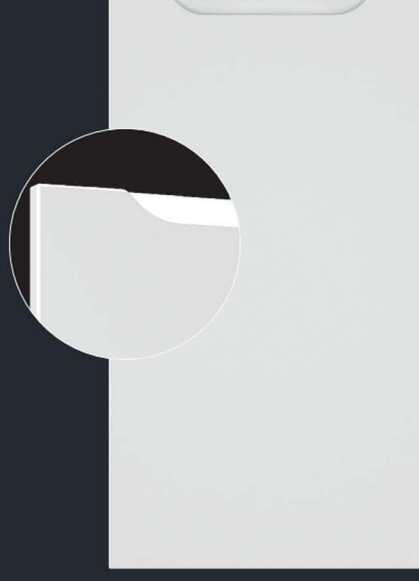

K-401

FRONT PANELS



K-51

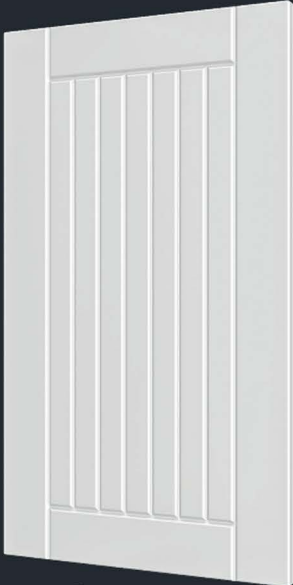

K-62



K-70

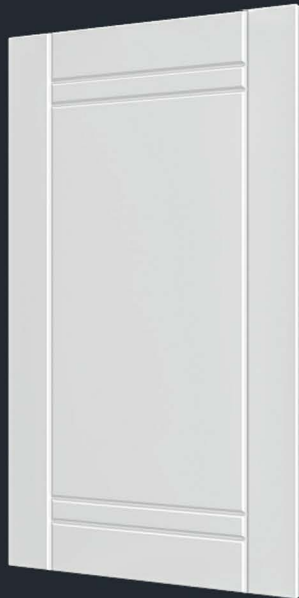

K-05

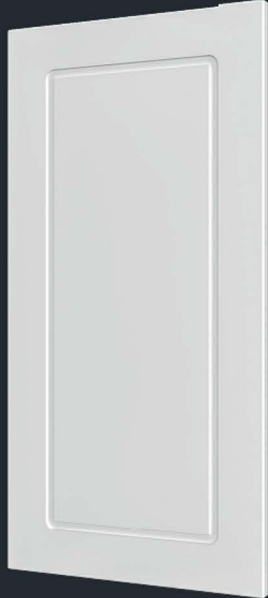

K-10



K-11



K-14

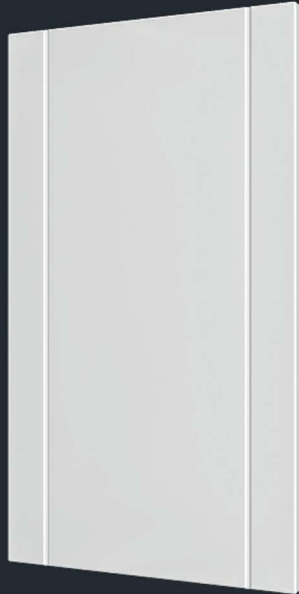

K-65



K-66



K-67

FRONT PANELS

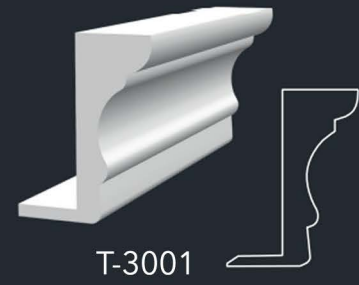

T-3001

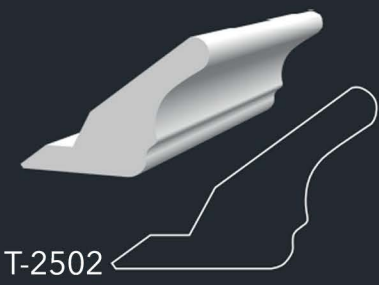

T-2502

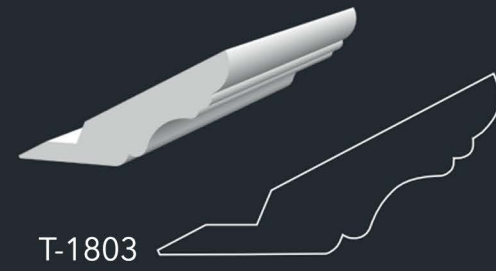

T-1803



T-3004



T-3005



T-3006



T-1807



T-1808



T-1809

COLOR PALETTE

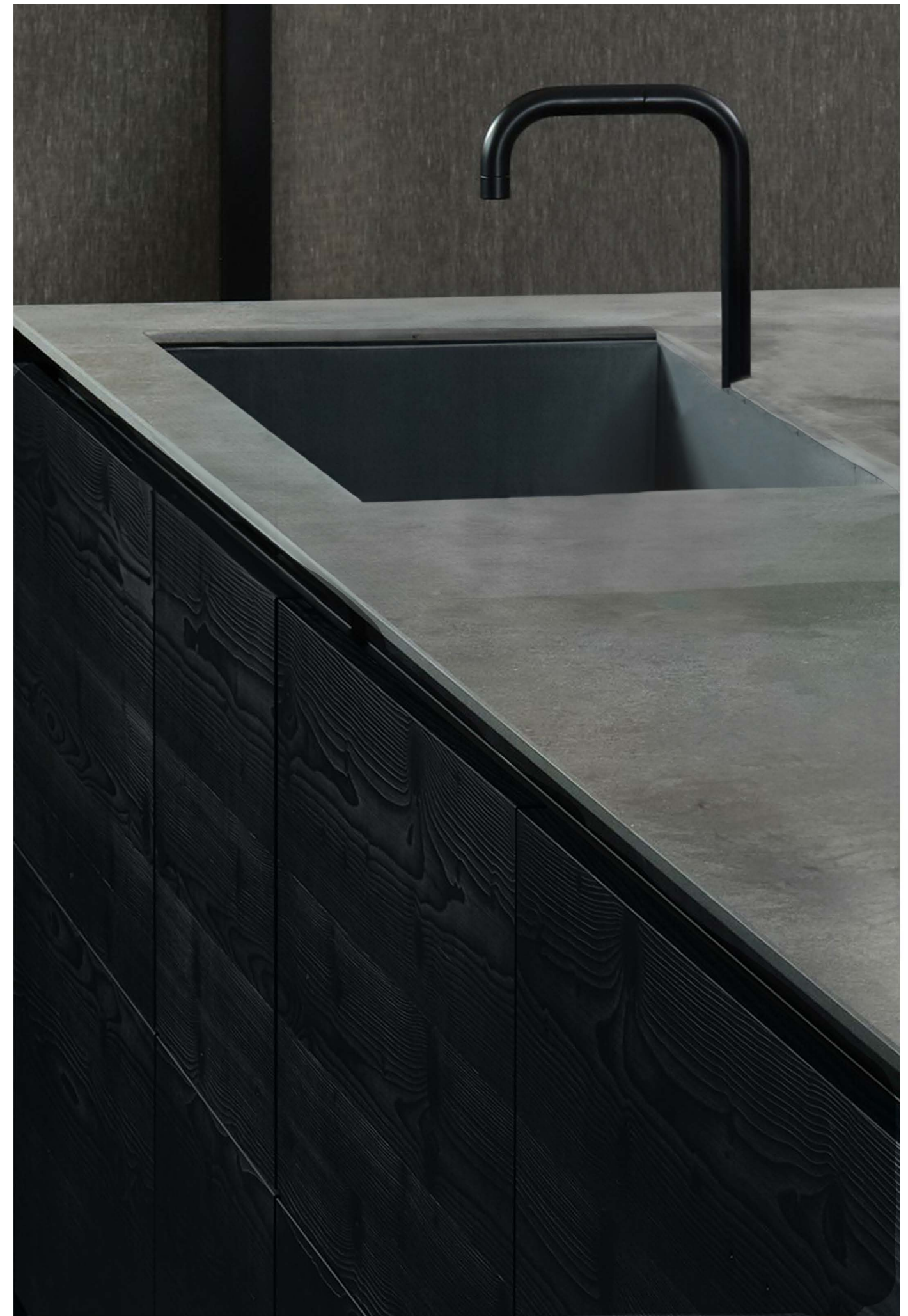
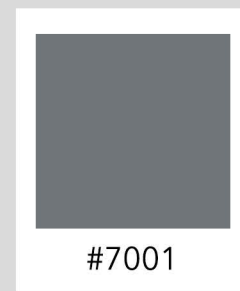
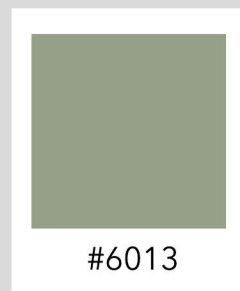
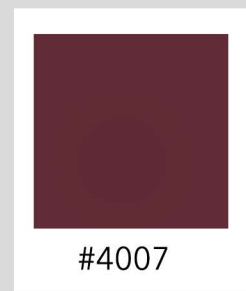
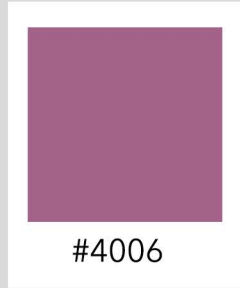

Our Signature Colors

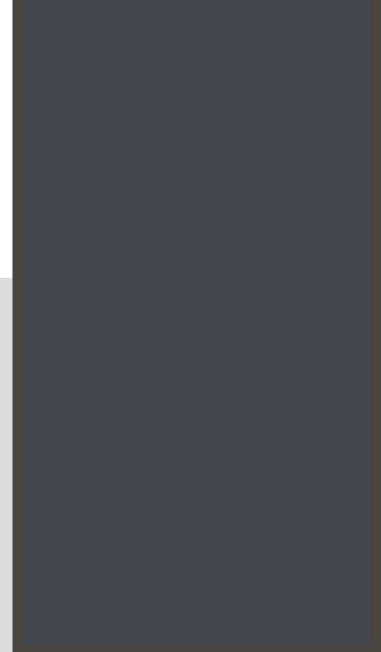

DARK BLUE

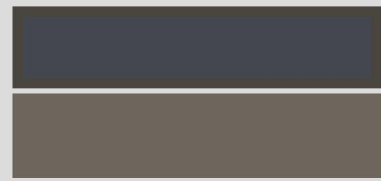

GREEN



#3269
DAMSON PLUM

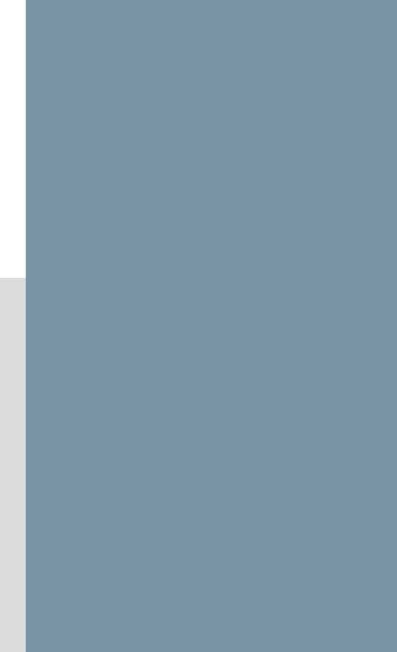
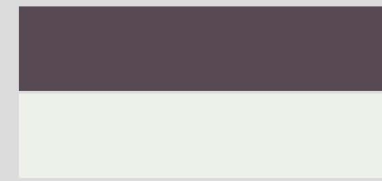

#3281
MUSON NEW

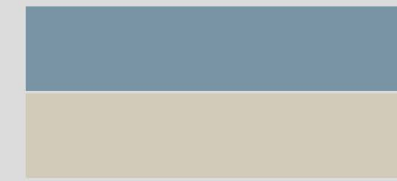

DARK GREY



BLUE



GREY



SOFT BROWN

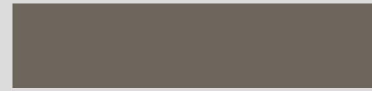

BROWN

CLOUD NEW
#3287

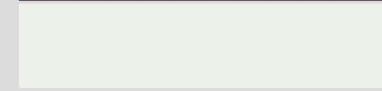

SEAGULL NEW
#3296

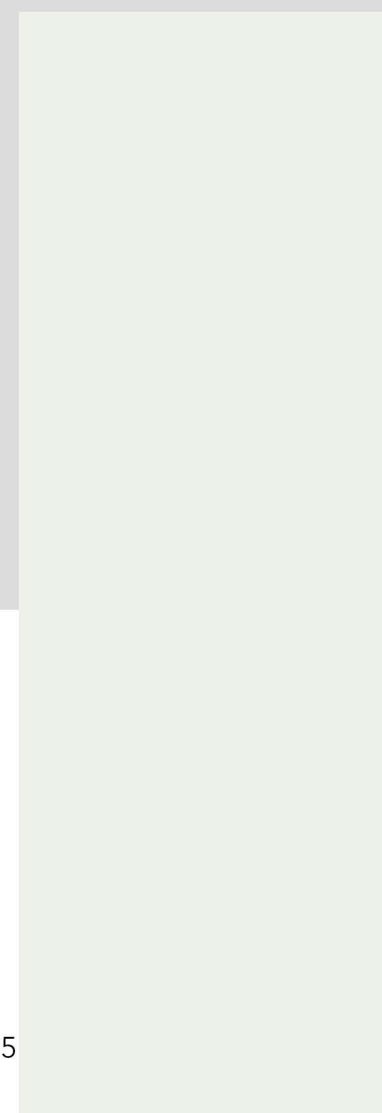

MANOLYA
#3107





Spray Painted Colors

RAL COLORS

Colour adds so much to your kitchen - tone and atmosphere, style, warmth, light, reflection and a sense of calm and clarity; we offer a huge range of colour choices for your kitchen design. Whether high-gloss or super-matt, you can pick the colour and finish that best represents the feeling you wish to evoke in your kitchen. We use multi-based lacquer systems explicitly developed for heavily used surfaces, moist areas and wipe-clean capabilities.

Laminated Surfaces

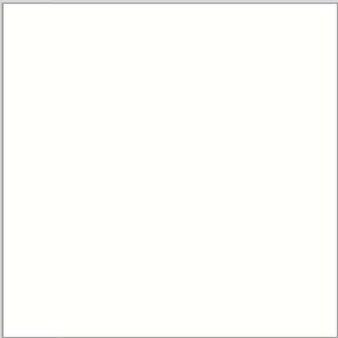

VT_068 WHITE

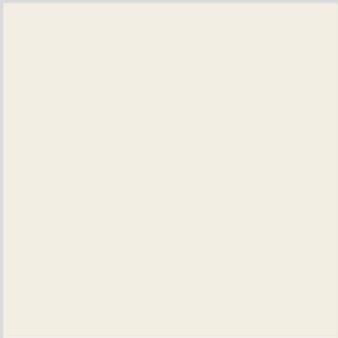

VT_568 PEARL CREAM



VT_969 OFFICE GREY



VT_828 MIST GREY

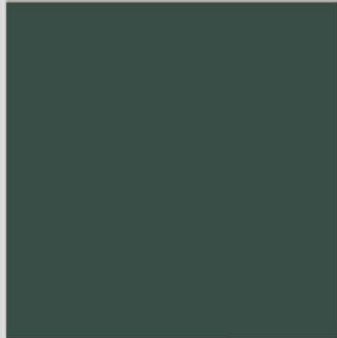

YT_88B SILVA



VT_265 VARIO VIZON



VT_459 EARTH



YT_84B ART



VT_285 DARK GREY

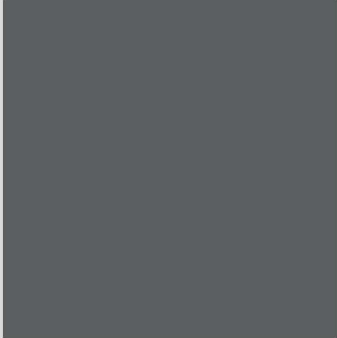

VT_829 CARBON GREY



YT_13C BOLD BLACK

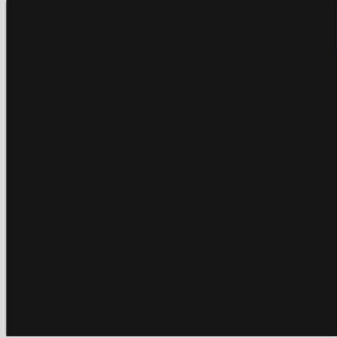

VT_037 BLACK



VT_823 SELENIT

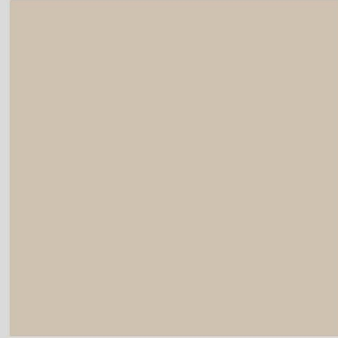

VT_538 SAND BEIGE

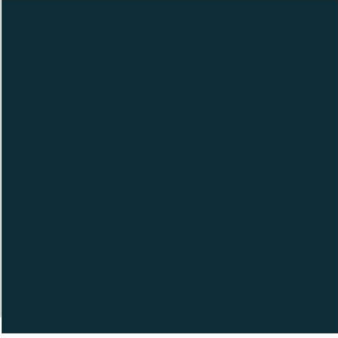

YT_36D
BLACK OF SMOKE

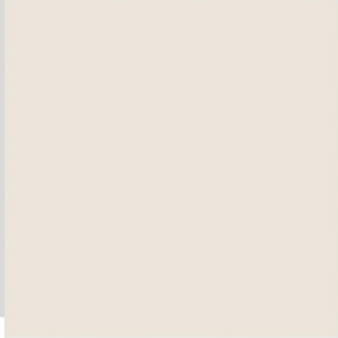

YT_35C
METALLIC SILK

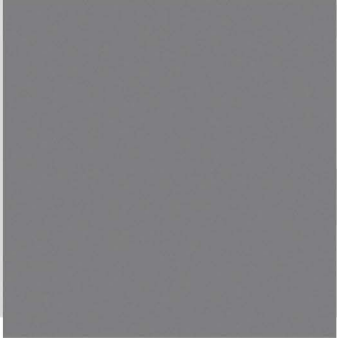

YT_36C
METALLIC ANTHRACITE

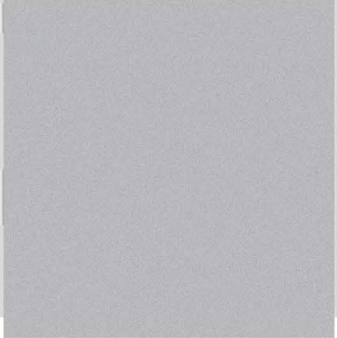

VT_344
METALLIC GREY

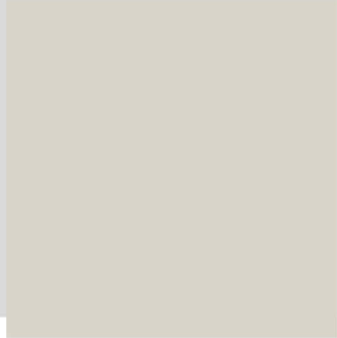

YT_73A
MOZAMBIQUE

Anti Fingerprint Surfaces Superior Matt Lacquered Panel

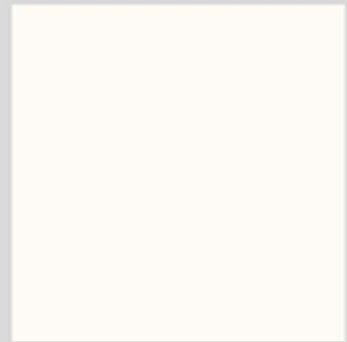

SML_263

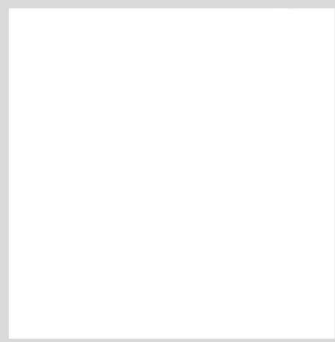

SML_068

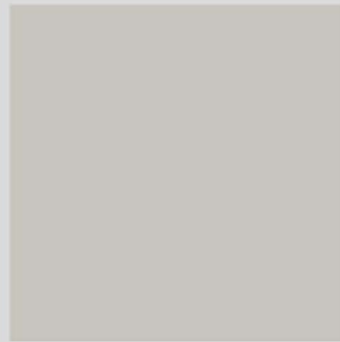

SML_73A

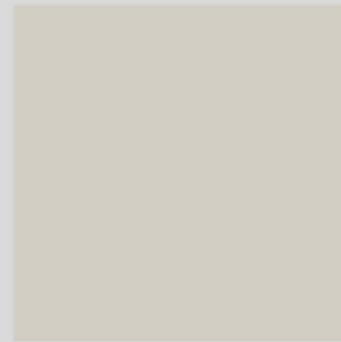

SML_828



SML_505



SML_829

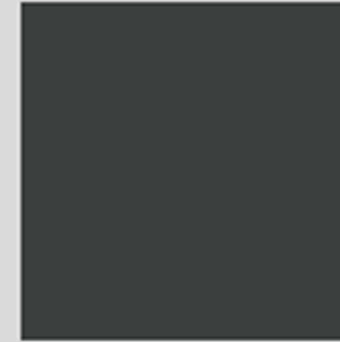

SML_285



Z117

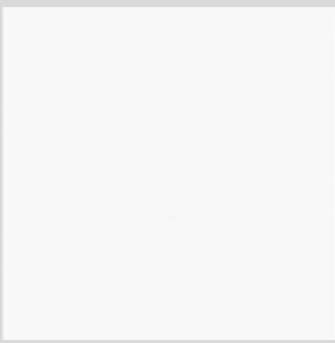

SML_568

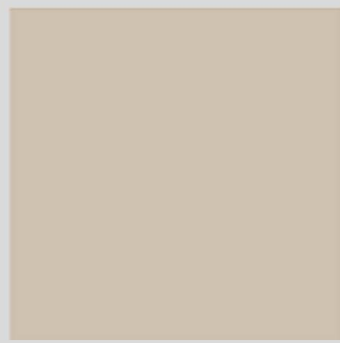

SML_538

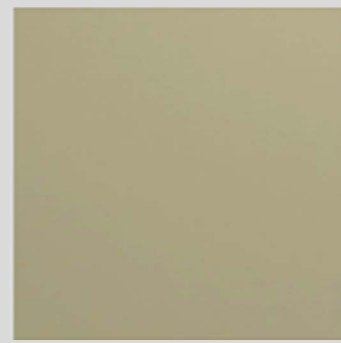

SML278



SML_823



SML74A



SML_037



SML_859



SML_770

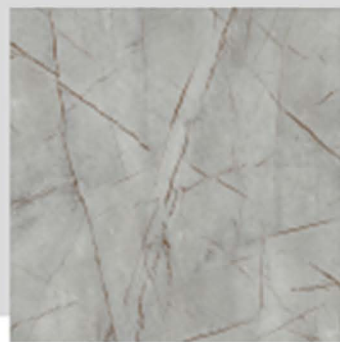

SML_98A



SML_715

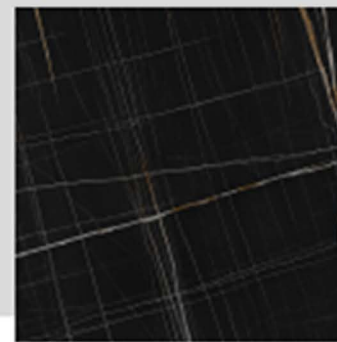

SML_02B



ANTI FINGERPRINT



MICRO SCRATCH RESISTANCE



LOW LIGHT REFLECTIVITY



IMPACT RESISTANCE



WATER REPELLANT



ANTIBACTERIAL



ULTRA WARM & SOFT TOUCH



DRY HEAT RESISTANCE



SCRATCH & ABRASION RESISTANCE



HIGH LIGHT FASTNESS



CHEMICAL RESISTANCE



HEAT & COLD RESISTANCE



EASY TO CLEAN



SAFE FOOD CONTACT



ULTRA MATT SURFACE



ANTISTATIC



ULTRA COLOR INTENSITY

COLOR & TEXTURE CONCEPTS

Metallic Textures



6020



5544 -
ALUMINI 05.11



6030

Metallics are a modern yet timeless choice for your kitchen. There are many ways you can incorporate the effect and colour into your design. This popular choice for kitchen design could range from a touch of metallic texture trim or front panels feature and anything in between.

Natural Stone & Concrete Textures



YT_715 IRONY

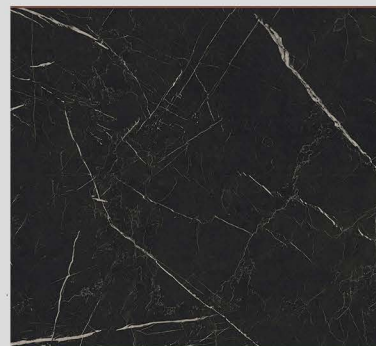

YT_51A ROYAL MARBLE



YT_55A PATARA BRONZE

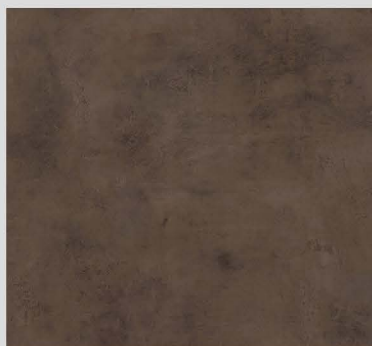

YT_45A RETRO BRONZE

The beauty of designing your kitchen is that you can have fun with the colours, textures and composition when considering your design.

Stone effects such as marble, granite and concrete are hugely popular and for a good reason. The textures add a tactile quality to an otherwise flat surface, the earth tones add warmth to the room, and the styles are timeless! The muted tones of stone blend easily with pretty much any colour scheme. They offer a flexible backdrop that's easy to build upon with colours of your choice. We offer a range of stone-effect and concrete kitchens to suit every taste.



YT_44A RETRO STONE



YT_43A RETRO SILVER



VT_770 MORMO

Textile Textures



F236 COTTON MINK

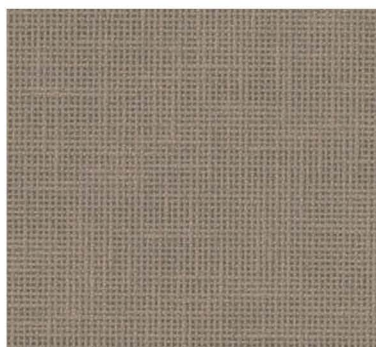

F237 COTTON LATTE

COLOR & TEXTURE CONCEPTS

Wood Effect Textures

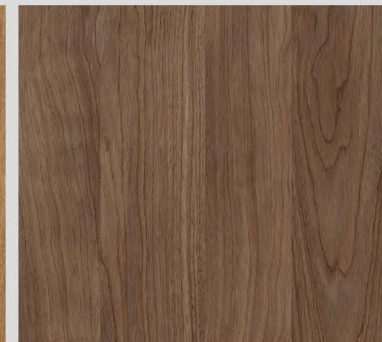
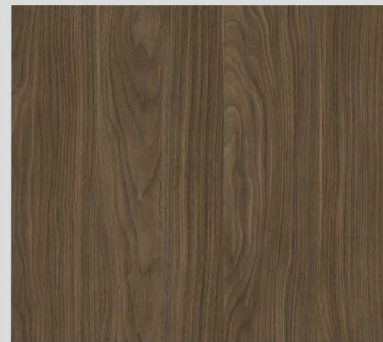

VT_778 LIGHT KESTINA

FG-681 SELANIK WALNUT

FG-673 HARRIS

FG-628 RIVIERA

FG-654 SAVANA OAK

FG-674 BIOKO

FG-659 AMAZON

FG-656 FALEZ

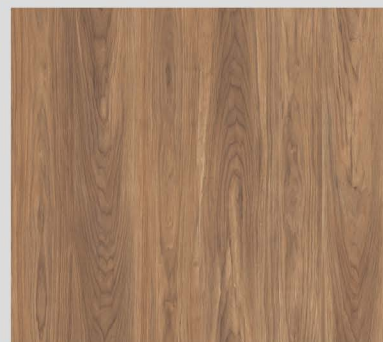

YT_75A TUVALU

VT_053 NILE WALNUT

VT_810 KAMAN WALNUT

VT_657 ATLANTIC PINE

VT_09A DORADO

VT_815 BEYZADE

VT_539 SAPPHIRE OAK

VT_681 DETROIT

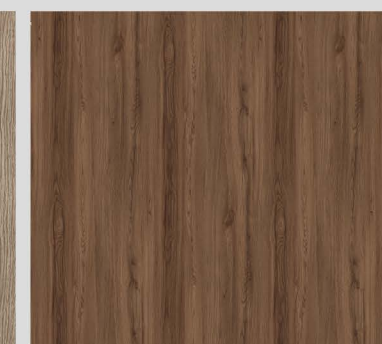
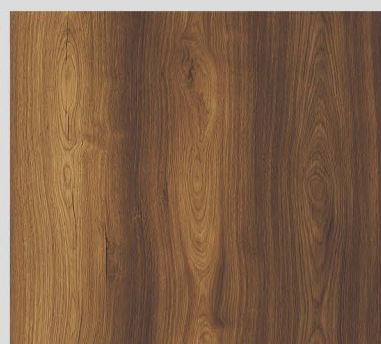
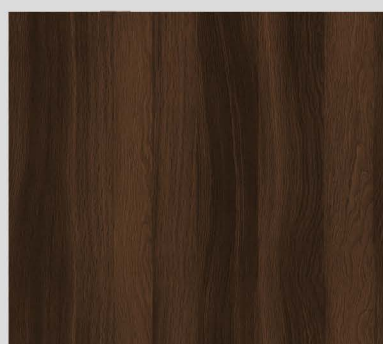

VT_395
MONSOON BIRCH

YT_06B MOON

YT_04B LUMIERE

YT_60A HAMILTON

YT_97B MOSO

YT_858 KANYON

YT_19D LIBERTA

VT_674 NAVARO



VT_49A AUTHENTIC OAK

VT_859 CASPIAN

VT_565
CAUCASION OAK

Wood effect textures and paint colours are a great way to add a natural, warm tone to your kitchen design. We use the highest-quality melamine coating, high-gloss, matt laminate and fingerprint-free laminate to produce impactful results for your home. We can deliver a suitable wood grain pattern to your kitchen inside and front panels, depending on the design.

HANDLES

Functional and beautiful, handles are more than just an afterthought regarding kitchen design; they are an integral piece of the design puzzle. They need to be comfortable in your hand (they will be used many times throughout the day), match the style of the room, and influence the kitchen space's overall aesthetics.

Handles emphasise the horizontal or vertical lines of the furnishings and the focal elements of the room. We can find the perfect handles for your home from materials and colour, shape and size, modern and elegant, or vintage and classic.



MODERN HANDLES

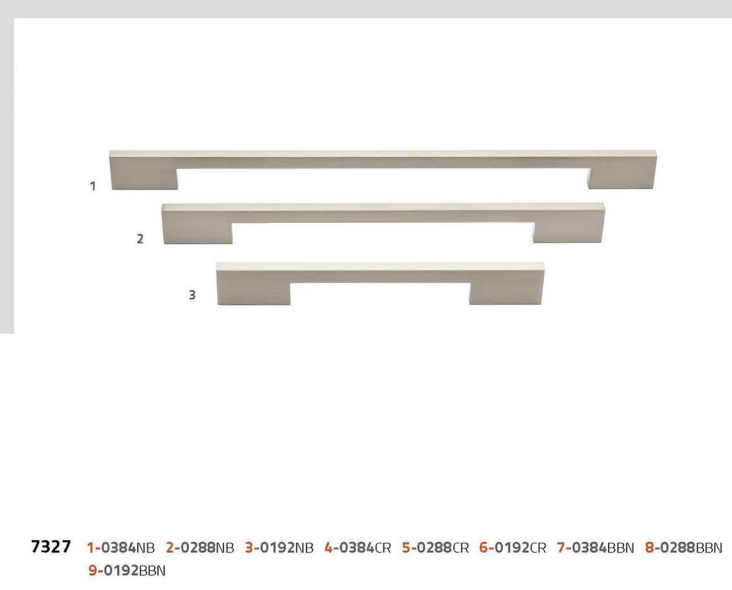
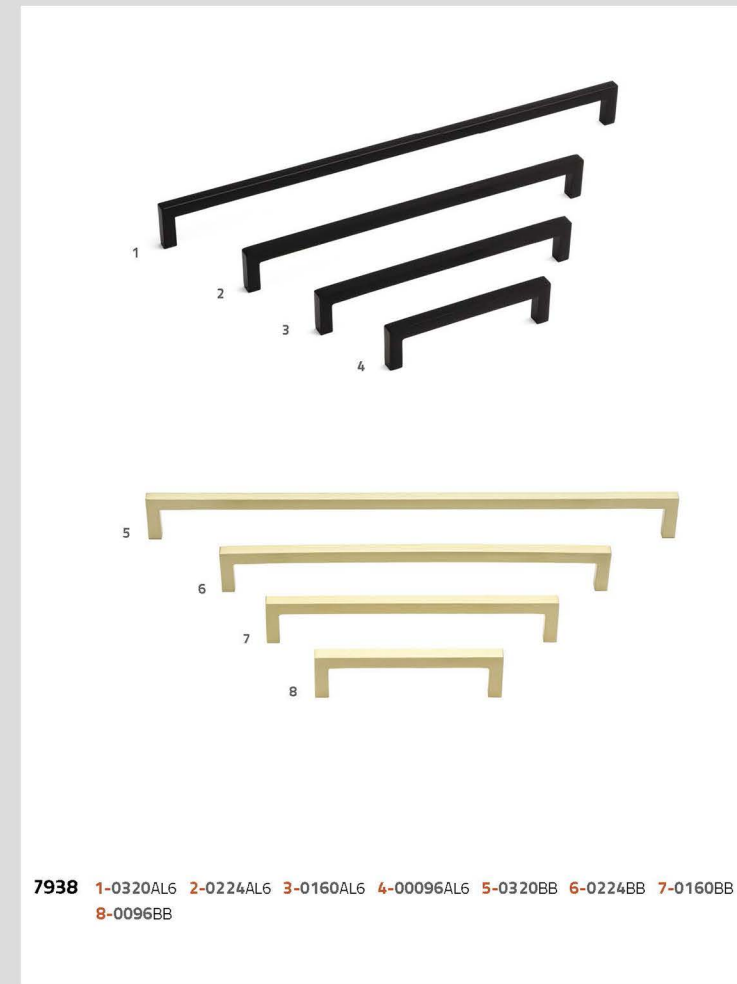
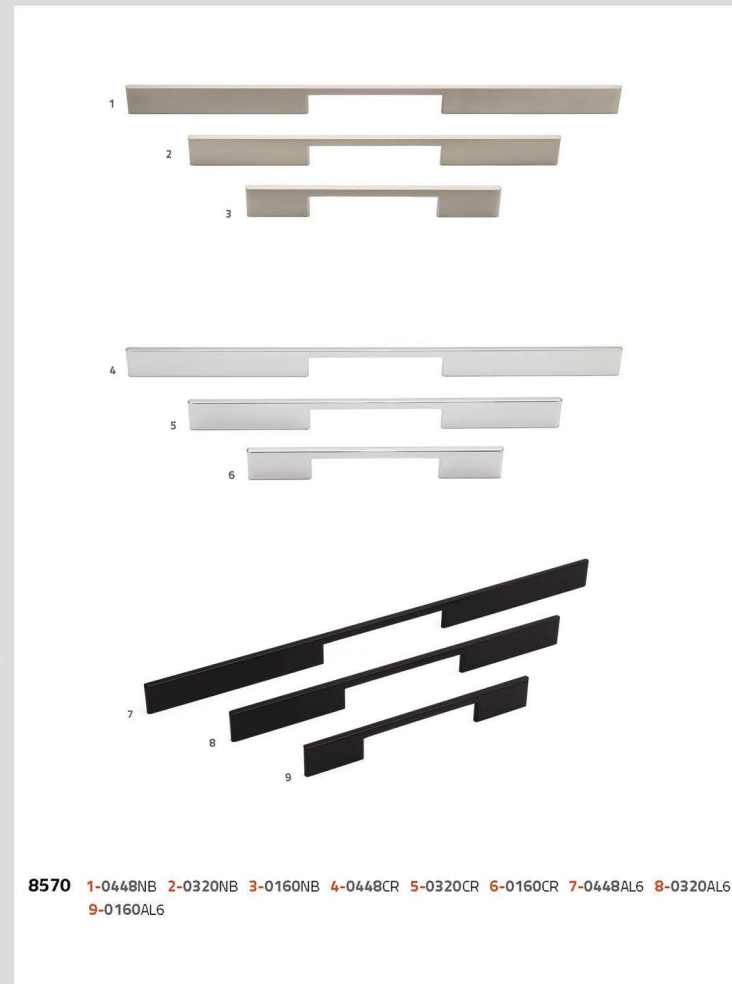

MODERN HANDLES

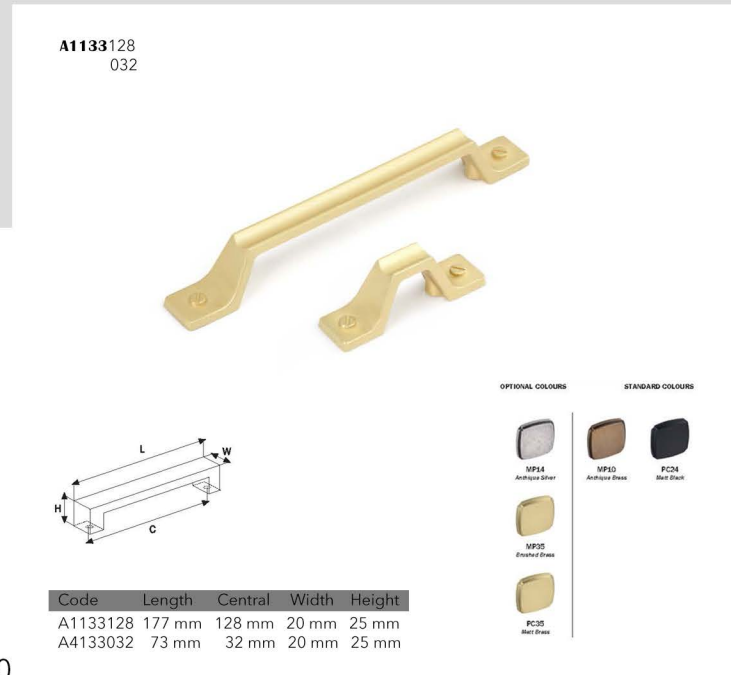
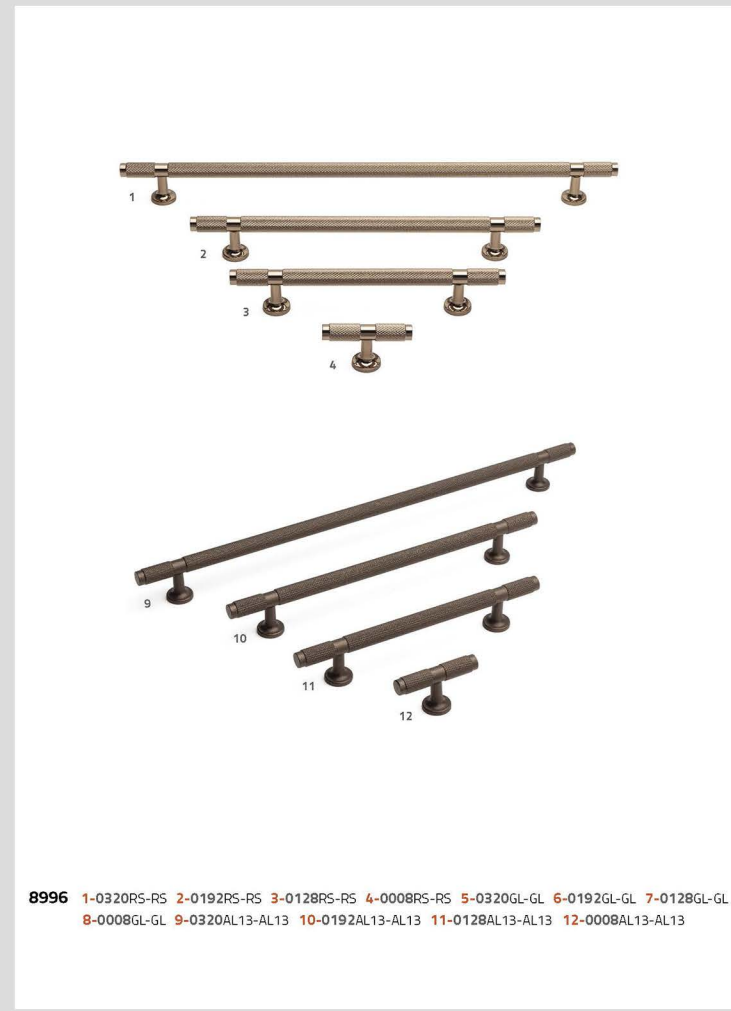
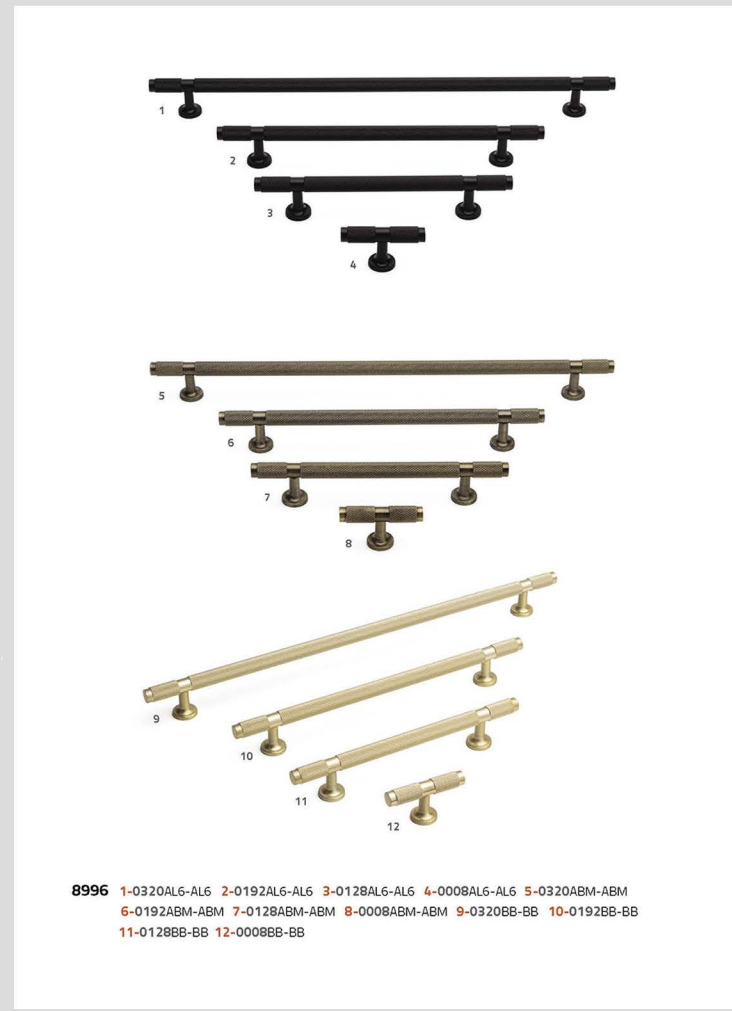
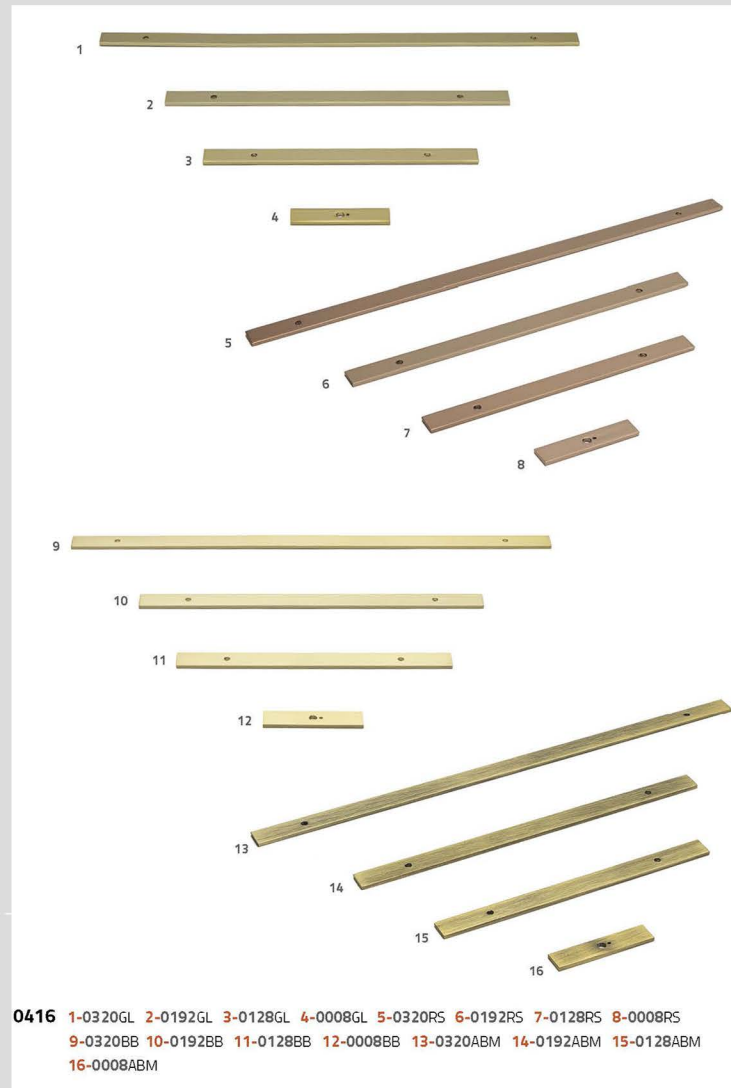

MODERN & CLASSIC HANDLES



4583 1-0160AL13 2-0096AL13 3-01600SM 4-00960SM • **4532** 5-0064AL13 6-00640SM
1935 7-0032AL13 8-00320SM



4665 1-0192ABM-AL6 2-0128ABM-AL6 3-0192PN-AL7 4-0128PN-AL7 5-0192PN-AL6 6-0128PN-AL6

A1174160

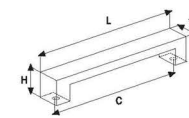

Code	Length	Central	Width	Height
A1174160	200 mm	160 mm	52 mm	17 mm



A1170096



A1170064

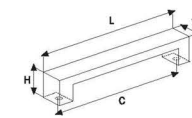

Code	Length	Central	Width	Height
A1170096	134 mm	96 mm	35 mm	22 mm
A1170064	102 mm	64 mm	35 mm	22 mm

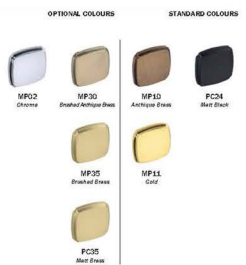

B 969192
128

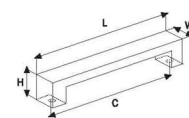

Code	Length	Central	Width	Height
B969192	314 mm	192 mm	21 mm	16 mm
B969128	250 mm	128 mm	21 mm	16 mm



KNOBS



1



2



3



4

7415 1-0016RS-RS 2-0016GL-GL 3-0016AL6-AL6 4-0016BB-BB



1



2



3



4

4335 1-0016NB 2-0016AL7 3-0016CR 4-0016AL6



1



2



3



4



5

1915 1-0032OSM 2-0032AL6 3-0032NB 4-0032PN 5-0032GL



1



2



3



4



5



6



7



8

1980 1-0032AL6 2-0032NB 3-0032BBN 4-0032CR 5-0032BB 6-0032ABM 7-0032RS 8-0032GL



WORKTOPS

Our quartz worktops are beautifully made, easy to clean and maintain and have excellent longevity. Usually made from manufactured stone and engineered using 93% natural quartz, along with various resins and polymers, the combination creates a wide range of strong, sleek finishes and is perfect for the kitchen.

Quartz offers the look of classic marble or timeless granite while still being durable and long-lasting. The material does not absorb liquids such as water, oils, wine, water and juices, making quartz a perfect choice for a kitchen surface.

Porcelain ceramic is a natural material; its manufacturing process involves finely ground raw minerals mixed, pressed and sintered in a high-temperature kiln. The surface, which is homogeneously compacted and hardened in the sintering process, is extremely robust, scratch resistant and insensitive to chemical influences. The surface is hygienic and easy to clean, making it a great choice of material for kitchen worktops. It is pleasant to touch and always looks pristine.

Solid wood worktops are attractive and robust. The solid wood is treated with a special oil to protect the surface before use. The typical wood patina is deliberate and indicates the genuine nature of the material. Solid wood worktops are available in oak, beech and walnut.

The Laminate kitchen worktops are a key feature for the overall design and layout of the space. Therefore, it has to satisfy challenging demands regarding durability, easy maintenance and aesthetics. They are manufactured in an elaborate high-pressure procedure using several layers of resin and paper. Once completed, the result is the meticulous worktop surfaces you use daily.



WORKTOPS

QUARTZ WORKTOPS



DAZE / Dekton - Onirika



MORPHEUS / Dekton - Onirika



ET CALATTA GOLD / Silestone - Eternal



REM / Dekton - Natural collection



ENTZO / Dekton - Natural collection



VANCOUVER / Sensa - Sensa premium



KIRA / Dekton - Natural collection



ARGA / Dekton-Stonika xgloss collection



CAFE EMPERADOR / Scalea -



PERLADO / Scalea -



PLATINO / Sensa - Sensa premium



KOVIK / Dekton - Natural collection

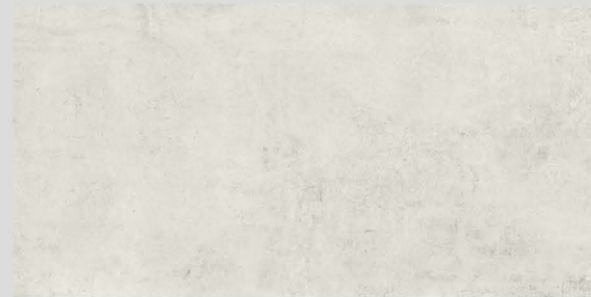

LUNAR / Dekton - Industrial collection



BERGEN / Dekton - Stonika xgloss coll.



SILVER GREY / Sensa

WORKTOPS

QUARTZ WORKTOPS



LAURENT / Dekton - Natural collection



KELYA / Dekton - Natural Collection



MAGNETIC BLUE / Scalea -



INDIAN BLACK / Sensa - Sensa premium



BLACK BEAUTY / Sensa - Sensa premium



LAOS / Dekton - Industrial collection



HELENA / Dekton - Stonika xgloss coll.

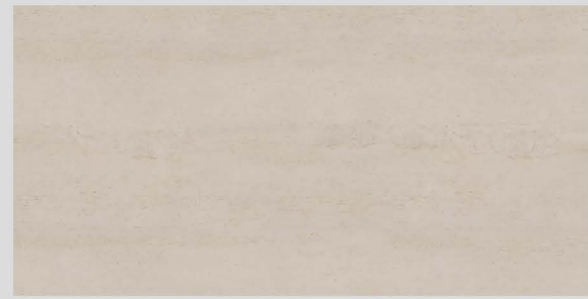

DANAЕ / Dekton- Natural collection



GRIS EXPO / Silestone - Mythology

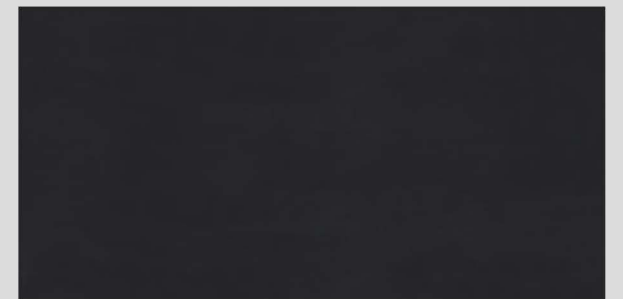

DOMOOS / Dekton - Solid collection

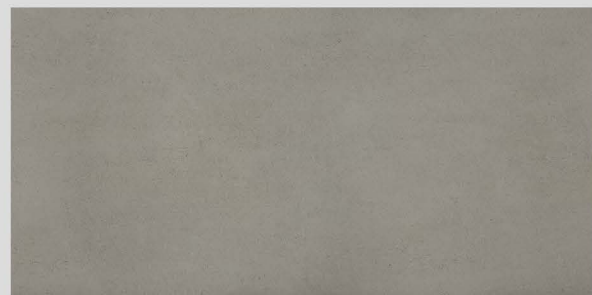

STRATO / Dekton - Tech collection

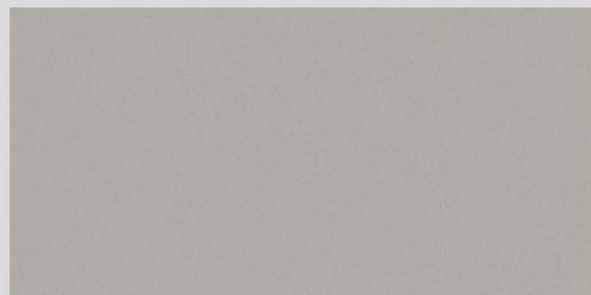

SIROCCO / Dekton - Natural collection

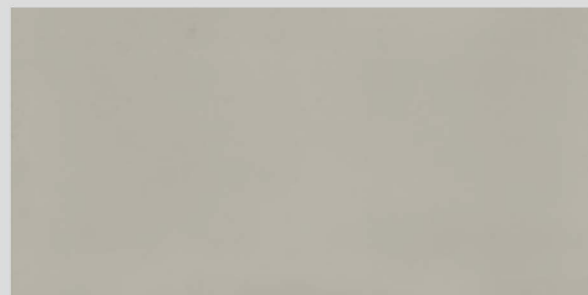

CINCEL GREY / Silestone - Sunlit days

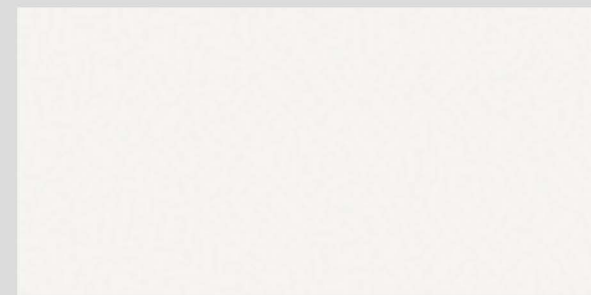

BLANCO ZEUS / Silestone - Mythology

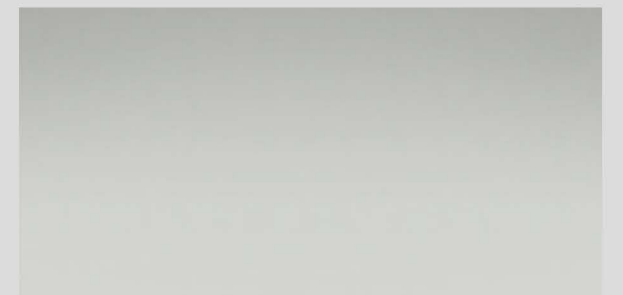

CALIZA NEVADA / Scalea -

WORKTOPS

PORCELAIN WORKTOPS



MARBLE LOOK - ALTISSIMMO



MARBLE LOOK - BRERA GREY



MARBLE LOOK - CALACATTA EXTRA



MARBLE LOOK - CAPRAIA



MARBLE LOOK - ELEGANT BLACK



MARBLE LOOK - GOLDEN WHITE



MARBLE LOOK - GRIGIO CARNICO



MARBLE LOOK - IMPERIALE



MARBLE LOOK - RAFFAELLO

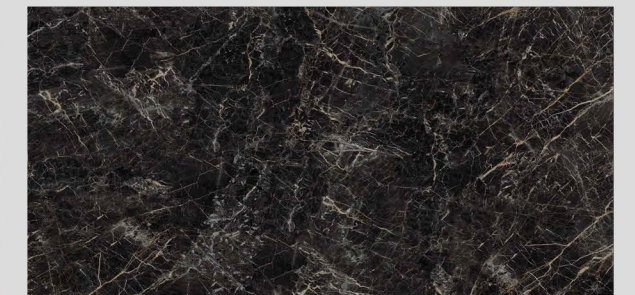

MARBLE LOOK - SAINT LAURENT



MARBLE LOOK - STATUARIO



MARBLE LOOK - VENA VECCHIA

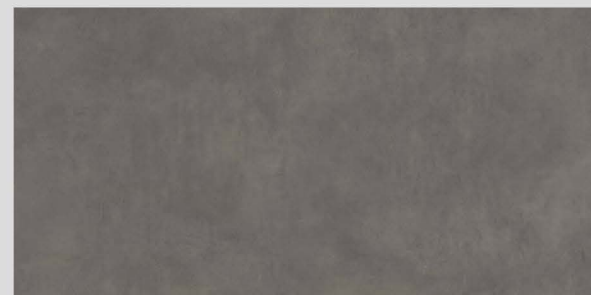

CONCRETE LOOK - GRAPHITE



CONCRETE LOOK - SMOKE



STONE LOOK - BASALTINA



STONE LOOK - BLUESTONE



STONE LOOK - GRIS



NATURAL LOOK - CEPPO DI GREY



METAL LOOK - IRON DARK



METAL LOOK - IRON LIGHT

WORKTOPS

LAMINATE



VINTAGE OAK



RUSTIC WOOD



BASQUE OAK LUXURY



LAPLAND BIRCH LUXURY



YUNNAN WALNUT LUXURY



SOFIA OAK



SHERWOOD OAK LUXURY



TENNESSEE HICKORY LUXURY



ARLINGTON OAK LUXURY



MARUYAMA CHERRY LUXURY



DARK WALNUT



DARK OAK

SOLID WOOD



PRIME OAK



WALNUT



IROKO

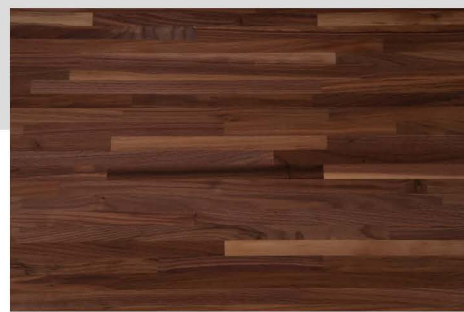

NARROW STAVE BLACK
AMERICAN WALNUT



SOLID ASH



CARAMEL BAMBOO





Parkshot House 5 Kew Road
Richmond TW9 2PR

0203 432 2770

info@studio20architects.co.uk



www.studio20architects.co.uk

